

Trimble® SPSx30 Total Station

User Guide



Version 1
Part Number 57048010
June 2011

Corporate Office

Trimble Navigation Limited
645 North Mary Avenue
PO Box 3642
Sunnyvale, CA 94085
USA

www.trimble.com

Contact Information

Trimble Navigation Limited
Engineering and Construction Division

5475 Kellenburger Road
Dayton, Ohio 45424-1099
USA

800-538-7800 (toll free in USA)
+1-937-245-5600 Phone
+1-937-233-9004 Fax

www.trimble.com

Copyright and Trademarks

© 2011, Trimble Navigation Limited. All rights reserved.

Autolock, Tracklight, Trimble and the Globe & Triangle logo are trademarks of Trimble Navigation Limited, registered in the United States Patent and Trademark Office and other countries. Microsoft and Windows are either registered trademarks or trademarks of Microsoft Corporation in the United States and/or other countries.

MagDrive, MultiTrack and SurePoint are trademarks of Trimble Navigation Limited.

The Bluetooth word mark and logos are owned by the Bluetooth SIG, Inc. and any use of such marks by Trimble Navigation Limited is under license.

All other trademarks are the property of their respective owners.

Release Notice

This is the June 2011 release version 1 of the Trimble SPSx30 Total Station user guide, part number 57048010. It applies to the Trimble SPSx30 Total Stations.

The following limited warranties give you specific legal rights. You may have others, which vary from state/jurisdiction to state/jurisdiction.

Product Warranty Information

For applicable product warranty information, please refer to the Warranty Card included with this Trimble product, or consult your Trimble dealer.

Registration

To receive information regarding updates and new products, please contact your local dealer or visit www.trimble.com/register. Upon registration you may select the newsletter, upgrade or new product information you desire.

Notices

The product contains a Bluetooth® device with QD ID B016013 combined with B015102.

Australia and New Zealand

This product conforms with the regulatory requirements of the Australian Communications Authority (ACA) EMC framework, thus satisfying the requirements for C-Tick Marking and sale within Australia and New Zealand.



Canada

This Class B digital apparatus complies with Canadian ICES-003.

This device complies with Industry Canada license-exempt RSS standard(s). Operation is subject to the following two conditions:

- (1) this device may not cause harmful interference, and
- (2) this device must accept any interference, including interference that may cause undesired operation of the device.

Cet appareil numérique de la classe B est conforme à la norme NMB-003 du Canada.

Le présent appareil est conforme aux CNR d'Industrie Canada applicables aux appareils radio exempts de licence. L'exploitation est autorisée aux deux conditions suivantes:

- (1) l'appareil ne doit pas produire de brouillage, et (2) l'utilisateur de l'appareil doit accepter tout brouillage radioélectrique subi, même si le brouillage est susceptible d'en compromettre le fonctionnement.

This device has been designed to operate with an antenna having a maximum gain of 2.0 dBi. Antennas having a higher gain are strictly prohibited per regulations of Industry Canada. The required antenna impedance is 50 ohms. To reduce potential radio interference to other users, the antenna type and its gain should be so chosen that the equivalent isotropically radiated power (EIRP) is not more than that required for successful communication.

The Radio Side Cover 2.4 GHz Part Number: 58050019, 58010012 and 58021007 contains radio module with IC: 4492A-2410G

The product contains radio module with IC: 5325A-0925.

Europe

This product has been tested and found to comply with the requirements for a Class B device pursuant to European Council Directive 89/336/EEC on EMC, thereby satisfying the requirements for CE Marking and sale within the European Economic Area (EEA). These requirements are designed to provide reasonable protection against harmful interference when the equipment is operated in a residential or commercial environment.



The product contains a radio module that applies to the R&TTED 1999/5/EC.



Devices marked with Part Numbers 58052019, 58012012 and 58022019 contain a radio module that applies to the R&TTED 1999/5/EC and are intended to be used only in France.



Devices marked with Part Numbers 58050019, 58010012 and 58021019

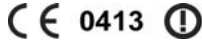

contain a radio module that applies to the R&TTED 1999/5/EC and are intended to be used in all European Community member states, except France.

The compliance to the applicable requirements is detailed in the official Declaration of Conformity document, which is filed at Trimble.

For product recycling instructions and more information, please go to www.trimble.com/ev.shtml.

Recycling in Europe: To recycle Trimble WEEE (Waste Electrical and Electronic Equipment, products that run on electrical power.), Call +31 497 53 24 30, and ask for the "WEEE Associate". Or, mail a request for recycling instructions to:



Trimble Europe BV
c/o Menlo Worldwide Logistics
Meerheide 45
5521 DZ Eersel, NL

Japan

The Radio Side Cover 2.4 GHz Part Number: 58010012 contains radio module with certificate number: 005NYCA0416.



The Bluetooth module has certificate number: 204WW11100300.

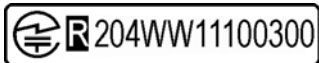

USA

Class B Statement – Notice to Users. This equipment has been tested and found to comply with the limits for a Class B digital device, pursuant to Part 15 of the FCC rules. These limits are designed to provide reasonable protection against harmful interference in a residential installation. This equipment generates, uses, and can radiate radio frequency energy and, if not installed and used in accordance with the instructions, may cause harmful interference to radio communication. However, there is no guarantee that interference will not occur in a particular installation. If this equipment does cause harmful interference to radio or television reception, which can be determined by turning the equipment off and on, the user is encouraged to try to correct the interference by one or more of the following measures:

- Reorient or relocate the receiving antenna.
- Increase the separation between the equipment and the receiver.
- Connect the equipment into an outlet on a circuit different from that to which the receiver is connected.
- Consult the dealer or an experienced radio/TV technician for help.

Changes and modifications not expressly approved by the manufacturer or registrant of this equipment can void your authority to operate this equipment under Federal Communications Commission rules. The antenna used for this transmitter must be installed to provide a separation distance of at least 20 cm from all persons and must not be co-located or operated in conjunction with any other antenna or transmitter.

Devices marked with Part Numbers: 58050019, 58010012 and 58021019 contains radio module with FCC ID: HSW- 2410G

The product contains radio module with FCC ID: PVH0925

**THIS DEVICE COMPLIES WITH PART 15
OF THE FCC RULES**

**OPERATION IS SUBJECT TO THE FOLLOWING
TWO CONDITIONS:**

**(1) THIS DEVICE MAY NOT CAUSE HARMFUL
INTERFERENCE, AND**

**(2) THIS DEVICE MUST ACCEPT ANY
INTERFERENCE RECEIVED, INCLUDING
INTERFERENCE THAT MAY CAUSE
UNDESIRE OPERATION**

Taiwan

Devices marked with Part Numbers: 58010012, 58050019 and 58021019 contains radio module with certificate number:

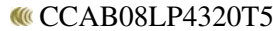

Battery Recycling Requirements

The product contains a removable Lithium-ion battery. Taiwanese regulations require that waste batteries are recycled.



Important Information

Laser Safety

Before using the instrument, make sure that you understand this user guide, as well as all equipment and job site safety requirements.

This equipment has been tested and found to comply with IEC 60825-1 2007, 21 CFR 1040.10, and 1040.11 except for deviations pursuant to Laser Notice No. 50, dated June 24, 2007.



Warning – Use of controls or adjustments or performance of procedures other than those specified herein may result in hazardous LED or laser radiation exposure. As with any bright light source, such as the sun, electric welding arcs or arc lamps, common sense applies. DO NOT look into the laser aperture when the laser is on. For further information regarding safe use of lasers, refer to the IEC 60825-1 June 24, 2007.

Queries

Address any questions you may have about laser safety to:

Trimble Navigation Limited

5475 Kellenburger Road

Dayton, OH USA 45424-1099

Attention: Laser Safety Officer, Quality Assurance Group

Phone (937) 233-8921 ext 824 or (800) 538-7800

Fax (937) 233-9661

Trimble SPSx30 DR Plus

The Trimble SPSx30 DR Plus is a CLASS 2 LASER PRODUCT



The instrument contains visible and invisible laser sources

- A laser diode for the distance measuring function operating at 905 nm (infrared, non-visible light), with a beam divergence of 0.4×0.8 mrad and an output power of <1.1 mW, LASER CLASS 1.
- A laser diode for laser pointer function operating at 630 - 680 nm (visible light), with a beam divergence of 0.3 mrad and an output power of <0.7 mW, while the emission is coaxial with the telescope. This mode operates in LASER CLASS 2.
- A tracker technology laser diode operates at 785 nm (infrared, non-visible light), with a beam divergence of 38.5 mrad and an out put power of <0.35 mW, while the emission is coaxial with the telescope. This mode operates in LASER CLASS 1.

When operating in prism mode with tracker technology and/or distance measurement the accessible radiation does not exceed the limits of LASER CLASS 1.

Trimble Target ID

The Trimble Target ID is a LASER CLASS 1 PRODUCT

CLASS 1 LASER PRODUCT

Trimble MT900 Target

The Trimble MT900 Target is a LASER CLASS 1 PRODUCT

CLASS 1 LASER PRODUCT

Trimble MT1000 MultiTrack Target

The Trimble MT1000 MultiTrack™ Target is a LASER CLASS 1 PRODUCT

CLASS 1 LASER PRODUCT

Battery Safety



Warning – Do not damage the rechargeable Lithium-ion battery. A damaged battery can cause an explosion or fire, and can result in personal injury and/or property damage. To prevent injury or damage:

- Do not use or charge the battery if it appears to be damaged. Signs of damage include, but are not limited to, discoloration, warping, and leaking battery fluid.
 - Do not expose the battery to fire, high temperature, or direct sunlight.
 - Do not immerse the battery in water.
 - Do not use or store the battery inside a vehicle during hot weather.
 - Do not drop or puncture the battery.
 - Do not open the battery or short-circuit its contacts.
-



Warning – Avoid contact with the rechargeable Lithium-ion battery if it appears to be leaking. Battery fluid is corrosive, and contact with it can result in personal injury and/or property damage. To prevent injury or damage:

- If the battery leaks, avoid contact with the battery fluid.
 - If battery fluid gets into your eyes, immediately rinse your eyes with clean water and seek medical attention. Do not rub your eyes!
 - If battery fluid gets onto your skin or clothing, immediately use clean water to wash off the battery fluid.
-



Warning – Charge and use the rechargeable Lithium-ion battery only in strict accordance with the instructions. Charging or using the battery in unauthorized equipment can cause an explosion or fire, and can result in personal injury and/or equipment damage. To prevent injury or damage:

- Do not charge or use the battery if it appears to be damaged or leaking.
 - Charge the Lithium-ion battery only in a Trimble product that is specified to charge it. Be sure to follow all instructions that are provided with the battery charger.
 - Discontinue charging a battery that gives off extreme heat or a burning odor.
 - Use the battery only in Trimble equipment that is specified to use it.
 - Use the battery only for its intended use and according to the instructions in the product documentation.
-

Environmental Information

NOTICE FOR TRIMBLE'S EUROPEAN UNION CUSTOMERS

Trimble is pleased to announce a new recycling program for our European Union customers. At Trimble, we recognize the importance of minimizing the environmental impacts of our products. We endeavor to meet your needs, not only when you purchase and use our products, but also when you are ready to dispose of them. That is why Trimble is actively pursuing, and will continue to pursue, the expanded use of environmentally friendly materials in all its products, and why we have established a convenient and environmentally friendly recycling program.

As Trimble makes additional recycling facilities available for your use, we will post their locations and contact information to our Recycling Instructions web page.

For product recycling instructions and more information, please go to

www.trimble.com/environment/summary.html



Recycling in Europe:

To recycle Trimble WEEE,

Call +31 497 53 2430, and ask for the “WEEE Associate”

Or

Mail a request for recycling instructions to:

Trimble Europe BV

c/o Menlo Worldwide Logistics

Meerheide 45

5521 DZ Eersel, NL



Declaration of Conformity

Trimble SPSx30 Total Station



P/N 57005021 Rev. C

Declaration of Conformity (DoC)



Issuer's name: Trimble AB
P.O. Box 64
SE-182 11 Danderyd
Sweden

Object of declaration: Trimble® SPS Total Stations

Type/Model	Part Number
SPS620 5'7.5" DR	58516021
SPS720 3'7.2" DR	58517021
SPS630 5'7.5" DR Plus	58501021
SPS730 3'7.2" DR Plus	58503021
SPS930 1'7.1" DR Plus	58504021

The object of declaration described above is in conformity with the essential requirements of the applicable directives, 2006/42/EC (MD), 2004/108/EC (EMCD) and 1999/5/EC (R&TTED) based on the following European harmonised standards:

MD:	EN ISO 12100:2010 IEC/EN 60825-1:2007	(Safety of machinery – Risk assessment and risk reduction) (Safety of laser products)
EMCD:	EN 61326-1:2006	(EMC for electrical equipment for measurement, control & laboratory use) Emission: Group 1 / Class B ISM equipment. Immunity: Requirements for equipment intended for use in industrial locations.
R&TTED:	EN 50371:2002 EN 60950-1:2006 EN 301489-17 V1.3.2 EN 301489-1 V1.8.1 EN 300328 V1.7.1	Art. 3(1)(a) Health Art. 3(1)(a) E1 Safety Art. 3(1)(b) EMC Art. 3(1)(b) EMC Art. 3(2) Spectrum

Signed for and on behalf of: Trimble AB
Date: June 16, 2011

Name and function: Fredrik Gylesjö, Manager of Engineering

Signature:

Trimble AB
Box 64, Rinkebyvägen 17
SE-182 11 Danderyd, Sweden

Telephone No: +46 8 622 1000
Telefax: +46 8 753 2464
www.trimble.com

Org.No: 556550-9782
VAT.No: SE556550978201

Trimble 2.4 GHz Radio



EC-Declaration of Conformity

to the Essential Requirements of the applicable
R&TTE Directive, 1999/5/EC, Annex IV

Product: 2.4 GHz radio

Types / Models

Robotic holder Global	58021019
Robotic holder France	58022019
Radio side cover 2.4GHz Global	58010019
Radio side cover 2.4GHz France	58012019
External radio 2.4GHz Global	58050019
External radio 2.4GHz France	58052019
Radio cover Trimble VX Global	58010011
Radio cover Trimble VX France	58012011
Radio cover SPS-series Global	58010012
Radio cover SPS-series France	58012012

Part Numbers

Manufacturer: Trimble AB
P.O. Box 64
SE-182 11 Danderyd
Sweden

The product complies with the essential requirements of the R&TTE Directive, 1999/5/EC, as shown in the Technical Construction File TCF/2007-01-15_RA_Am.1 certified by the Notified Body 0413, reference number 608185.

Technical references

Article 3.1(a)	Health	1999/519/EC
Article 3.1(a)	EI. Safety	EN 61010-1:2001
Article 3.1(b)	EMC	EN 301 489-17
Article 3.2	Radio	ETS 300 328-2 V1.6.1
EMCD	EMC	EN 61000-6-2:2001



As manufacturer, we declare under our sole responsibility that the equipment follows the provisions of the Directive stated above.

Danderyd 2007-02-06

.....
Martin Holmgren
Engineering Manager

Trimble AB
Box 64, Rinkebyvägen 17
SE-182 11 Danderyd, Sweden

Telephone No: +46 8 622 1000
Telefax: +46 8 753 2464
www.trimble.com

Org.No: 556550-9782
VAT.No: SE356550978201

Trimble Target ID



P/N 57012021 Rev. A

Declaration of Conformity (DoC)



Issuer's name: Trimble AB
P.O. Box 64
SE-182 11 Danderyd
Sweden

Object of declaration: Trimble® Accessory

<i>Type/Model</i>	<i>Part Number</i>
Target ID	58314019

The object of declaration described above is in conformity with the essential requirements of the EMC Directive 2004/108/EC (EMCD) based on the following European harmonised standards:

EMCD: EN 61000-6-2:2005 (EMC, Generic standards – Immunity for industrial environments)
EN 61000-6-3:2006 (EMC, Generic standards – Emission standard for residential, commercial and light industrial environments)

Signed for and on behalf of: Trimble AB
Date: April 6, 2010
Name and function: Peter Fredriksson, Director of Engineering

Signature:

Trimble AB
Box 64, Rinkebyvägen 17
SE-182 11 Danderyd, Sweden

Telephone No: +46 8 622 1000
Telefax: +46 8 753 2464
www.trimble.com

Org.No: 556550-9782
VAT.No: SE556550978201

Trimble MultiTrack Target



P/N 57013021 Rev. A

Declaration of Conformity (DoC)



Issuer's name: Trimble AB
P.O. Box 64
SE-182 11 Danderyd
Sweden

Object of declaration: Trimble® Accessory

Type/Model	Part Number
MultiTrack target	58003013

The object of declaration described above is in conformity with the essential requirements of the EMC Directive 2004/108/EC (EMCD) based on the following European harmonised standard:

EMCD: EN 61326-1:2006 (EMC for electrical equipment for measurement, control & laboratory use)
Emission: Group 1 / Class B ISM equipment.
Immunity: Requirements for equipment intended for use in industrial locations.

Signed for and on behalf of: Trimble AB
Date: April 6, 2010
Name and function: Peter Fredriksson, Director of Engineering

Signature:

Trimble AB
Box 64, Rinkebyvägen 17
SE-182 11 Danderyd, Sweden

Telephone No: +46 8 622 1000
Telefax: +46 8 753 2464
www.trimble.com

Org.No: 556550-9782
VAT No: SE556550978201

Contents

Environmental Information	viii
1 Introduction	
Welcome	2
Related Information	2
Technical Assistance	2
Your Comments	2
Registration	2
2 Inspection, Care and Maintenance	
Inspecting the Container	4
Instrument Case	4
Storing the Carrying Straps	6
Power Kit Accessory Case	8
Robotic Kit Accessory Case.	9
Backsight Target Kit Accessory Case	10
Attaching the Accessory Case to the Instrument Case	11
Care and Maintenance	12
Cleaning	12
Getting Rid of Moisture	12
Transporting the Instrument.	13
Servicing	13
3 Getting Started	
Battery	16
Battery Safety and Environment Information	16
Charging the Lithium-Ion Battery	17
Dual Slot Battery Charger.	17
Battery Charger (5 Slot).	17
Conditioning the Battery	18
Battery Charger LED Behavior.	20
Inserting the Internal Battery	21
Trimble Multi Battery Adapter	22
Connecting the Trimble Multi Battery Adapter	23
Instrument Description	25
On/Off Key	26
Face 2 Display	27
Optical Plummet	29
Handle	30
Laser and LED Information	32

4	Setup	
	Setup36
	Setup Stability36
	Measurement Stability36
	Starting the Instrument37
	Leveling40
	Instrument Setup41
	Security43
	PIN Code43
	PUK Code47
	Radio Settings49
	Bluetooth® Settings53
	Adjustments Menu54
	Firmware Version Information68
	Service Info70
	Select Language70
	Exit Menu71
	The Laser Pointer72
	Aligning the Laser Pointer72
	Adjusting the Laser Beam73
	Measuring the Instrument Height76
	Adjusting the Optical Plummet78
	Pre Measurement Check List80
	Attaching the Trimble CU/Face Plate Cover81
	Detaching the Trimble CU/Face Plate Cover82
	Connecting a TSC384
	Servo and Autolock Mode84
	Robotic Mode86
	Lifting the Instrument87
5	Instrument Operation Methods	
	Introduction90
	Conventional Measurement with Servo90
	Autolock Measurement90
	Robotic Measurement91
	Reflectorless Measurement91
	Machine Control & Machine Guidance91
	Advance Tracking Sensor (ATS) Capability92
6	Instrument Technology	
	3D Positioning Technology94
	Correction for Mislevelment94
	Correction for Collimation Errors94
	Correction for Trunnion Axis Tilt96

Averaging Measurements to Reduce Sighting Errors	97
Distance Measuring Technology	98
DR Plus	98
Beam Divergence	99
Trajectory Server	101
Tracker Technology	102
Aiming	104
How to Check Aiming	104
Tracklight	105
Servo Technology	106
Position Servo	107
Focus Servo	107
Power Management	109
Stand Alone	109
Instrument with Trimble CU Connected	109
Power Supply	111
Internal Power Supply	111
External Power Supply	112
Charging the Battery	113
Battery Low Message	114
External Communication	114

7 Options & Accessories

Trimble Stake Writer Rod	116
Trimble Target ID	116
Trimble MT900 Target	120
Junction Box	121
Trimble MT1000 MultiTrack Target	122
Features	123
Measures	124
Fitting and Removing the Battery	124
Measuring the Backsight Target Height	127
Trimble Robotic Holder	129
Power Management	130
Attaching a Battery	131
Detaching a Battery	131
Attaching a Trimble CU	133
Detaching a Trimble CU	134
Attaching the Trimble Robotic Holder to the Rod	135
Detaching the Trimble Robotic Holder from the Rod	136
Radio	137
Internal Radio	137
External Radio 2.4 GHz	138
Attaching the Battery	139

Detaching the Battery	140
Radio Antenna Extension Kit	141

Index

Introduction

In this chapter:

- Welcome
- Related Information
- Technical Assistance
- Your Comments
- Registration

Welcome

Welcome to the Trimble SPSx30 Total Station user guide. This manual describes how to setup and use the Trimble SPSx30 Total Station. Even if you have used an optical total station before, Trimble recommends that you spend some time reading this manual to learn about the special features of this product.

In this user guide Trimble SPSx30 Total Station refers to all the available models Trimble SPS630, SPS730 and SPS930 Total Station. When the description needs to be distinguished between the models they will be referred to as Trimble SPS630, SPS730 or SPS930 Total Station.

Related Information

For more information about this product, please visit our web site at:

www.trimble.com

Technical Assistance

If you have a problem and cannot find the information you need in the product documentation, **contact your local Distributor**. Alternatively, request technical support using the Trimble web site at:

www.trimble.com

Your Comments

Your feedback about the supporting documentation helps us to improve it with each revision.

E-mail your comments to ReaderFeedback@trimble.com.

Registration

To receive information regarding updates and new products please register on the Trimble web site.

www.trimble.com/register

Inspection, Care and Maintenance

In this chapter:

- Inspecting the Container
- Instrument Case
- Power Kit Accessory Case
- Robotic Kit Accessory Case
- Backsight Target Kit Accessory Case
- Care and Maintenance
- Transporting the Instrument
- Servicing

Inspecting the Container

Inspect the shipping container. If the container arrives in poor condition, examine the equipment for visible damage. If damage is found, immediately notify the carrier and your Trimble sales representative. Keep the container and the packing material for the carrier to inspect.

Instrument Case

When unpacking the instrument, check that all ordered items are received. Below is an example of where all items can be placed in the instrument case. See figure 2.1.

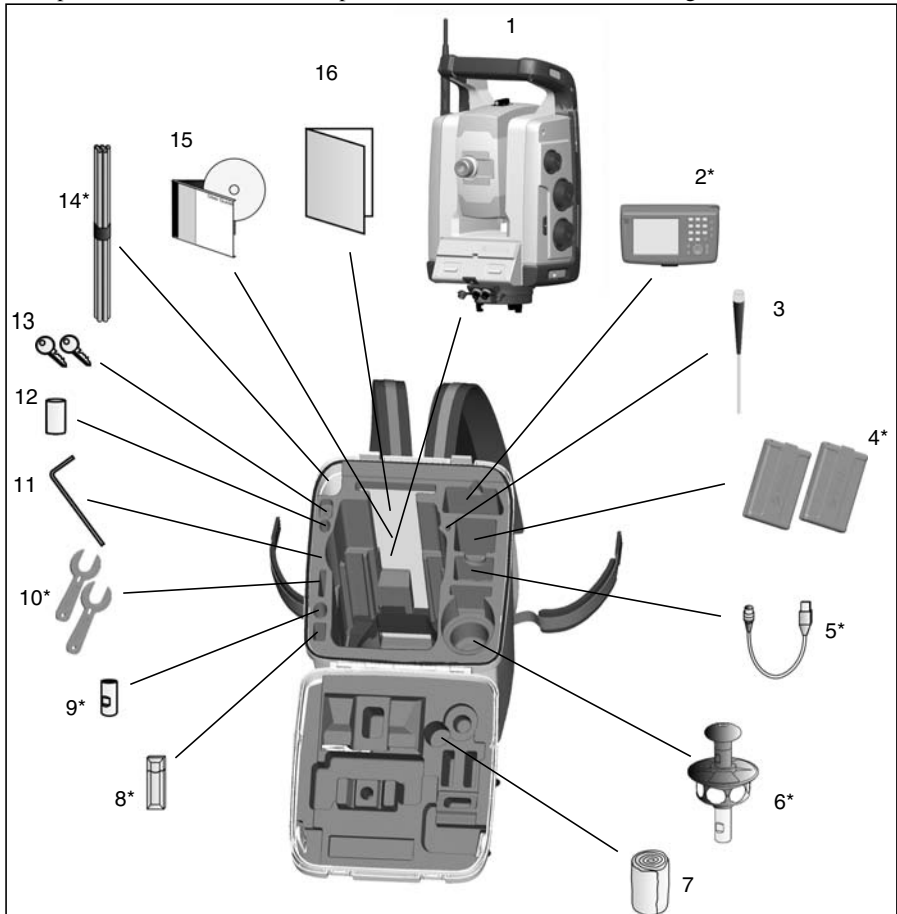

Figure 2.1 Position of items in the instrument case

Note – * Not included in the box.

Note – Some of the items described in figure 2.1 are optional and not all of the items are delivered with the instrument, some items are delivered with the accessory kits.

Item	Description
1	Trimble SPSx30 Total Station instrument
2	Trimble CU**
3	Allen key
4	Internal batteries (2x)**
5	Cable to USB for USB Stick or CF Card**
6	360° prism with mini-rod**
7	Rain cover
8	Memory stick**
9	Mini-rod adapter**
10	Tools for target ID (2x)**
11	Tool for handle (Torx T30 key)
12	Tools for tribrach and optical plummet
13	Instrument case keys (2x)
14	Instrument height meter**
15	Trimble SPS Series Total Station user guide CD
16	Getting Started Guide and Quick Reference Card Lens rain cover (not shown in figure) Cover for panel holder, mounted on instrument (not shown in figure)

** Non standard item



Caution – When shipping an instrument, make sure that the Trimble CU is not attached to the instrument. Place the Trimble CU in its own compartment in the transport case to avoid damage to the instrument. See Figure 2.1

Storing the Carrying Straps

When you are not using the carrying straps, you can store them in the carrying strap compartment on the instrument case.



Tip – Put the waist straps into the carrying strap compartment first, before the shoulder straps.

To take out and use the carrying straps:

1. Press the compartment lid lock downward and open the carrying strap compartment. See figure 2.2

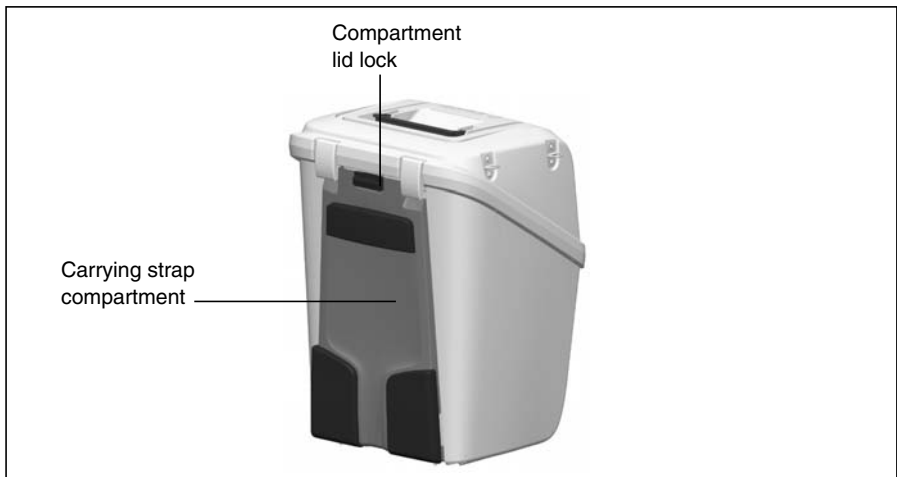

Figure 2.2 Instrument case with the carrying straps inside the compartment

2. Lift the straps from the compartment. The straps are already attached to the instrument case. See figure 2.3



Figure 2.3 Fitting the carrying straps

3. Close the compartment lid, making sure that you do not jam the carrying straps. See figure 2.4



Figure 2.4 Instrument case with the carrying straps ready for use

Power Kit Accessory Case

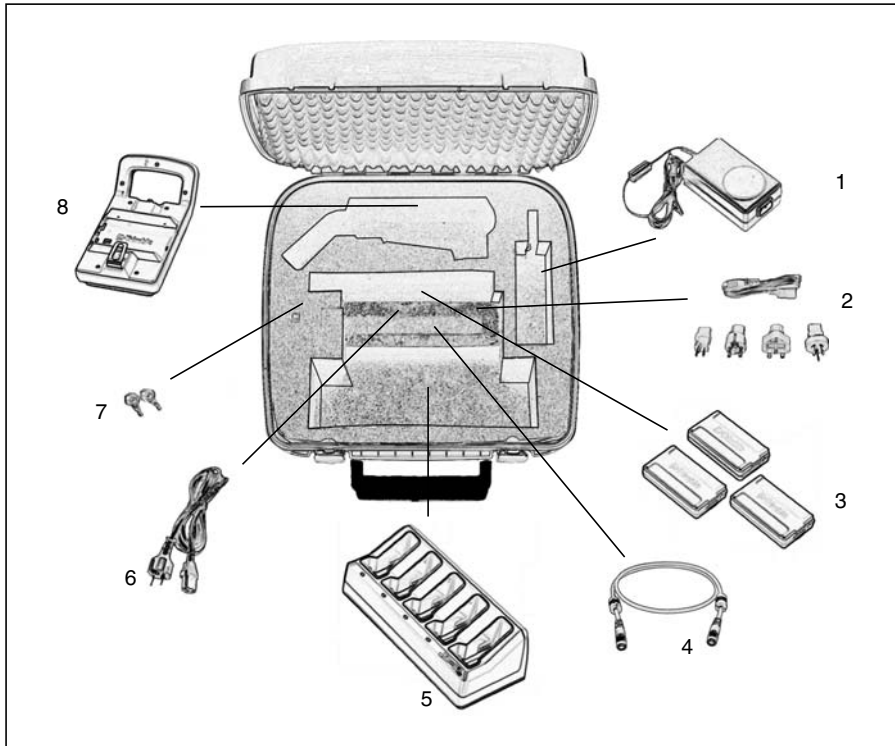

Figure 2.5 Power kit accessory case. The figure shows an example of where to place items in the case.

Item	Description
1	Battery charger power supply
2	Power adapter kit
3	Batteries (robotic power kit 3 batteries) (servo and Autolock power kit 2 batteries)
4	Power cable
5	Battery charger
6	External battery power cable
7	Accessory case keys (2x)
8	Multi-battery adapter (Included in robotic power kit only)

Robotic Kit Accessory Case

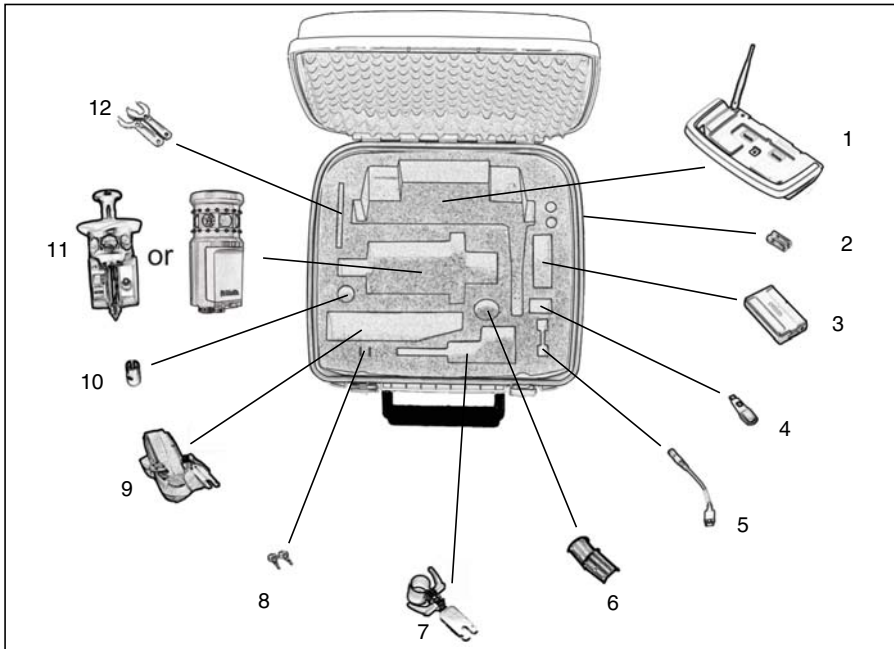

Figure 2.6 Contents of the robotic kit accessory case

Item	Description
1	Trimble Advanced Holder
2	Size AA batteries (2x)**
3	Battery
4	Memory stick (not included)
5	Cable to USB for USB Stick or CF Card (included with control unit)
6	Rod adapter
7	Standard rod adapter
8	Accessory case keys (2x)
9	Carrying strap
10	Mini-rod adapter
11	360° Prism with mini-rod and Target ID or MultiTrack™ Target
12	Tools for Target ID (2x)

** Non standard item

Backsight Target Kit Accessory Case

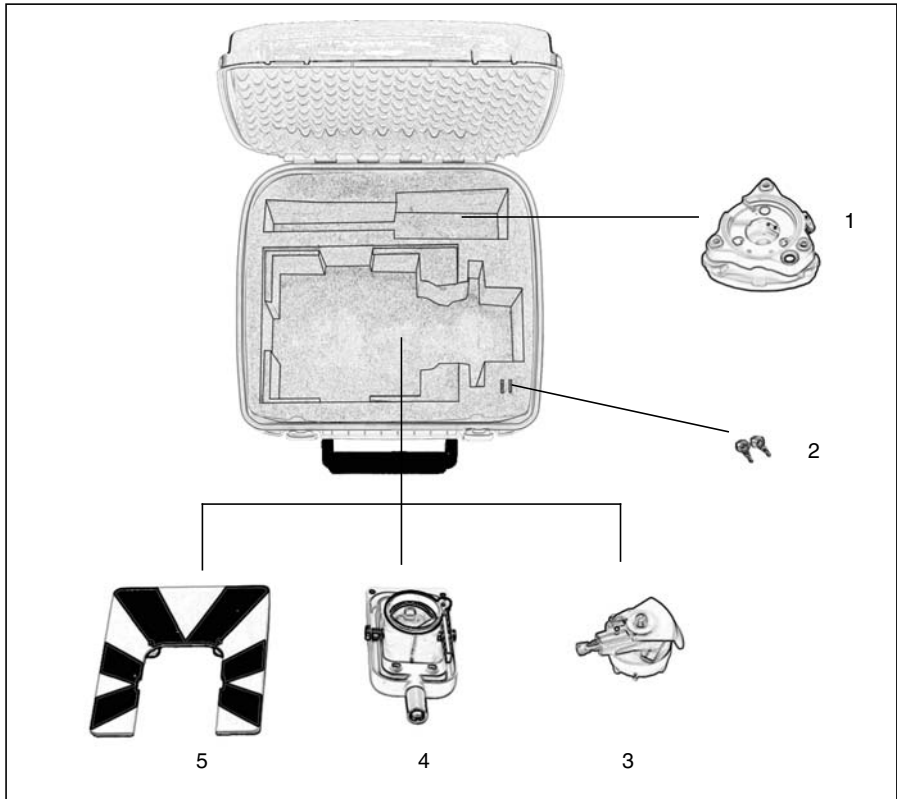

Figure 2.7 Contents of the backsight target kit accessory case

Item	Description
1	Tribrach
2	Accessory case keys (2x)
3	Prism base with level and optical plumb
4	Prism
5	Sighting target

Attaching the Accessory Case to the Instrument Case

The accessory case can be fitted on top of the instrument case for transport to a job site. Use straps (not included) as shown in figure 2.8.



Figure 2.8 Accessory case fitted to the top of the instrument case

Care and Maintenance



Warning – Do not remove the instrument cover from the instrument. A Trimble SPS Total Station is designed to withstand normal electromagnetic disturbance from the environment but it contains circuits that are sensitive to static electricity. If an unauthorized person opens the instrument cover, the function of the instrument is not guaranteed and the warranty is invalidated.

The Trimble SPSx30 Total Station is designed and tested to withstand field conditions, but like all precision instruments, it requires care and maintenance. Take the following steps to get the best results from the instrument:

- Do not subject the equipment to rough jolts or careless treatment.
- Keep the lenses and reflectors clean. Use only lens paper or other material that is designed for cleaning optical equipment.
- Keep the instrument protected and in an upright position, preferably in the instrument case.
- Do not carry the instrument while the instrument is mounted on a tripod. Doing so can damage the tribrach screws.
- Do not carry the instrument by the telescope barrel. Use the handle.
- When you need extremely precise measurements, make sure that the instrument has adapted to the surrounding temperature. Significant variations in instrument temperature can affect precision.

Cleaning



Caution – Never use strong detergents such as benzine or thinners on the instrument or the instrument case.

Be very careful when cleaning the instrument, especially when removing sand or dust from lenses and reflectors. Never use coarse or dirty cloth or hard paper. Trimble recommends that you use anti-static lens paper, a cotton wad, or a lens brush.

Getting Rid of Moisture

If the instrument has been used in damp weather, take the instrument indoors and remove the instrument from the instrument case. Leave the instrument to dry naturally. If condensation forms on the lenses, allow the moisture to evaporate naturally. Leave the carrying case open until all moisture has evaporated.

Transporting the Instrument

Always transport the instrument in a locked instrument case. For longer trips, transport the instrument in the instrument case and inside the original shipping container.



Caution – When shipping an instrument, make sure that the Trimble CU is not attached to the instrument. Place the Trimble CU in its own compartment in the transport case to avoid damage to the instrument. See Figure 2.1

Servicing

Note – There are no user-serviceable parts on the Trimble SPSx30 Total Station.

Trimble recommends that you take the instrument to an authorized Trimble service workshop for service and calibration once a year. This is to guarantee that the specified positioning accuracies are maintained.

When you send the instrument to a service center, clearly write the name of the sender and the receiver on the instrument case. If repairs are required, enclose a note in the instrument case. The note should clearly describe any fault or symptoms, and indicate that servicing is required.

Getting Started

In this chapter:

- Battery
- Instrument Description
- Laser and LED Information

Battery

Before charging or using a battery it is important that you read and understand the battery safety and environment information.

Battery Safety and Environment Information



Warning – Do not damage the rechargeable Lithium-ion battery. A damaged battery can cause an explosion or fire, and can result in personal injury and/or property damage. To prevent injury or damage:

- Do not use or charge the battery if it appears to be damaged. Signs of damage include, but are not limited to, discoloration, warping, and leaking battery fluid.
 - Do not expose the battery to fire, high temperature, or direct sunlight.
 - Do not immerse the battery in water.
 - Do not use or store the battery inside a vehicle during hot weather.
 - Do not drop or puncture the battery.
 - Do not open the battery or short-circuit its contacts.
-



Warning – Avoid contact with the rechargeable Lithium-ion battery if it appears to be leaking. Battery fluid is corrosive, and contact with it can result in personal injury and/or property damage. To prevent injury or damage:

- If the battery leaks, avoid contact with the battery fluid.
 - If battery fluid gets into your eyes, immediately rinse your eyes with clean water and seek medical attention. Do not rub your eyes!
 - If battery fluid gets onto your skin or clothing, immediately use clean water to wash off the battery fluid.
-



Warning – Charge and use the rechargeable Lithium-ion battery only in strict accordance with the instructions. Charging or using the battery in unauthorized equipment can cause an explosion or fire, and can result in personal injury and/or equipment damage. To prevent injury or damage:

- Do not charge or use the battery if it appears to be damaged or leaking.
 - Charge the Lithium-ion battery only in a Trimble product that is specified to charge it. Be sure to follow all instructions that are provided with the battery charger.
 - Discontinue charging a battery that gives off extreme heat or a burning odor.
 - Use the battery only in Trimble equipment that is specified to use it.
 - Use the battery only for its intended use and according to the instructions in the product documentation.
-

Disposal

- Before disposal, discharge the battery.

- Dispose of the used battery in an environmentally sensitive manner, according to local and national regulations, see also Environmental Information page viii.

Charging the Lithium-Ion Battery

The battery is supplied partially charged. Charge the battery completely before using it for the first time.

- To charge the battery, use only a charger that is recommended by Trimble for charging the Lithium-ion battery.
- Charge the battery before using the total station if the equipment has been stored for longer than six months.

Dual Slot Battery Charger

The Dual slot battery charger is supplied with it's own user instructions and is therefore not deccribed in this user guide. Refer to the Charger Kit Dual Slot user instructions for more information.



Figure 3.9 Dual Slot Battery Charger

Battery Charger (5 Slot)

The battery charger operates between 0 °C (32 °F) and 40 °C (104 °F). Charging a battery at temperatures in the range of 0 °C (32 °F) to 5 °C (41 °F) will take longer than charging at room temperature.



Caution – Ensure that nothing obstructs the vents in the back of the charger. The bottom of the charger is hot during charging.

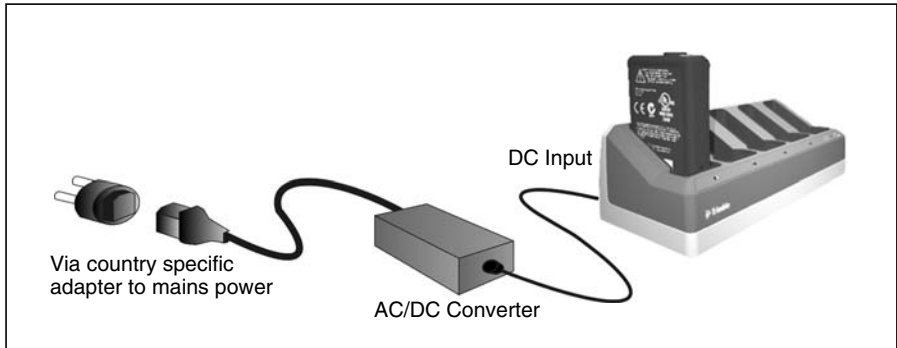

Figure 3.10 Battery charger (5 slot)

To charge the battery:

1. Ensure that the vents in the back of the charger are unobstructed.
2. Place the charger on a hard, flat and level surface, to ensure that there is airflow under the charger.
3. To apply power to the charger, use the AC to DC converter. The charger scans the slots for a battery. The green light flashes on the slot that is being scanned.
4. Place the battery in any of the slots. For an explanation of the LED display, see page 20.
5. Charging takes approximately 3 hours per battery at room temperature. If several batteries are charging in the battery charger, the batteries will be charged sequentially, from left to right.

Leave a deeply discharged or shorted battery overnight in the charger to attempt to revive the battery. A shorted battery is typically revived as soon as the slot is scanned. If the Amber LED turns off, the battery is revived. If the Amber LED stays on, the battery is no longer functional and needs to be replaced.

Conditioning the Battery

Charge the battery as described above. Ensure that the vents in the back of the charger are unobstructed and that the charger is on a flat and level surface.

If the Amber LED for a slot is flashing, the battery occupying this slot requires conditioning.

A battery that has been subjected to 20 consecutive incomplete charge/discharge cycles requires conditioning and will trigger the conditioning-required indicator. A full charge/discharge cycle is defined as one that uses more than 90% of the battery capacity. A battery requires conditioning if the power gauge (a count of the battery capacity) in the battery is misreading the battery capacity by more than 8%. The battery is still safe to use, but the power gauge may no longer be accurate which may decrease the battery run time in the field.

Using all the battery capacity before charging will reset the indicator. The charger also has the capability to perform a conditioning cycle.

To condition the battery:

1. Press the conditioning button on the back of the charger. Amber LEDs become solid, and all green LEDs start to flash. Release the conditioning button. See figure 3.11

In the conditioning mode, the charger discharges any battery that requires conditioning and then charges it.

Conditioning a single battery can take up to 24 hours. Conditioning five batteries can take up to 60 hours. Trimble recommends that you condition the battery or batteries on a weekend.



Caution – The bottom of the charger is hot during conditioning. Do not touch the bottom plate.

2. If you press the conditioning button again when conditioning is in progress, you cancel conditioning. To succeed, a conditioning cycle must be uninterrupted.



Figure 3.11 Battery charger conditioning button

Battery Charger LED Behavior

Status	Amber LED	Green LED
No battery detected (or battery defective)	ON	OFF
Battery detected (charging not started)		
Conditioning not required	OFF	OFF
Conditioning required	FLASHING	OFF
Charging in progress		
Conditioning not required	OFF	FLASHING
Conditioning required	FLASHING	FLASHING
Conditioning in progress	ON	FLASHING
Conditioning done (battery fully charged)	ON	ON
Battery fully charged		
Conditioning not required	OFF	ON
Conditioning required	FLASHING	ON

For information about the battery power gauge LEDs, see also Power Supply page 111

Inserting the Internal Battery

The TrimbleSPSx30 Total Station internal battery fits into the battery compartment on the side of the instrument. This battery can easily be removed and replaced. To insert the battery:

1. Unclip the battery compartment door
2. Slide the battery into the battery compartment with the battery connectors positioned towards the top of the instrument. See figure 3.12



Figure 3.12 Removing and replacing the internal battery

Trimble Multi Battery Adapter



Warning – Use only the specified battery and cable with the Multi Battery Adapter. Use the adapter only to provide power to the specified Trimble product. Never attempt to charge batteries while they are in the adapter. Observe the warnings in the battery section of the manual.

The Multi Battery Adapter is an external battery adapter that holds and connects up to three Trimble SPSx30 Total Station batteries. The Multi Battery Adapter has a hook so that the adapter can be attached to the tripod. See figure 3.13

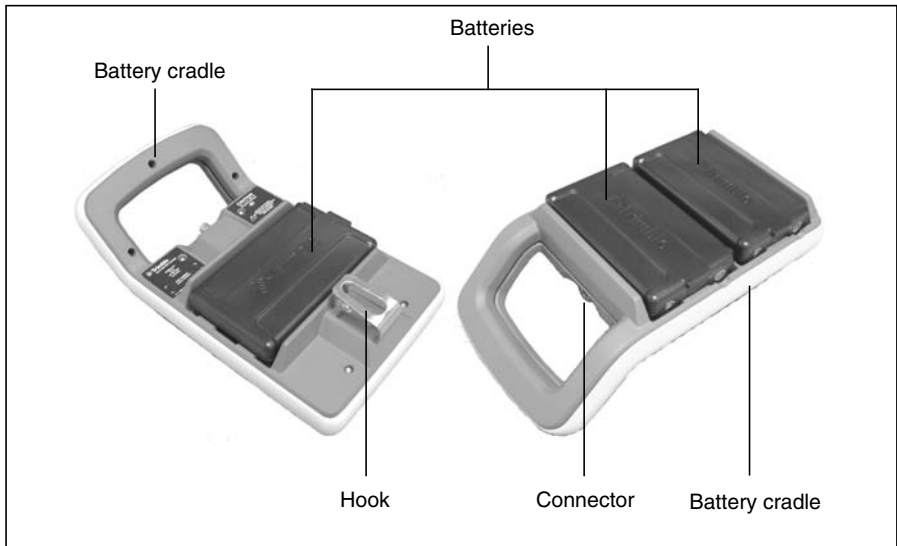

Figure 3.13 Multi Battery Adapter

Connecting the Trimble Multi Battery Adapter

The Trimble Multi Battery Adapter can be connected to the Trimble SPSx30 Total Station instrument with a standard Trimble 6-pin Hirose battery cable. See figure 3.14



Caution – Use only the gray cables with 6-pin Hirose connectors from Trimble when connecting a cable to the instrument and Multi Battery Adapter.

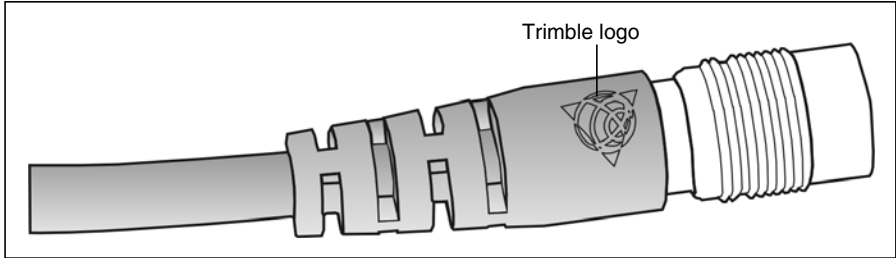

Figure 3.14 Connecting the Multi battery Adapter

3 Getting Started



Tip – When connecting the cable to the instrument, keep the Trimble logo on the connector upward.



Instrument Description

This section describes the instrument controls. Trimble recommends that you take some time to familiarize yourself with the names and the locations of the controls. See figure 3.15 and figure 3.16

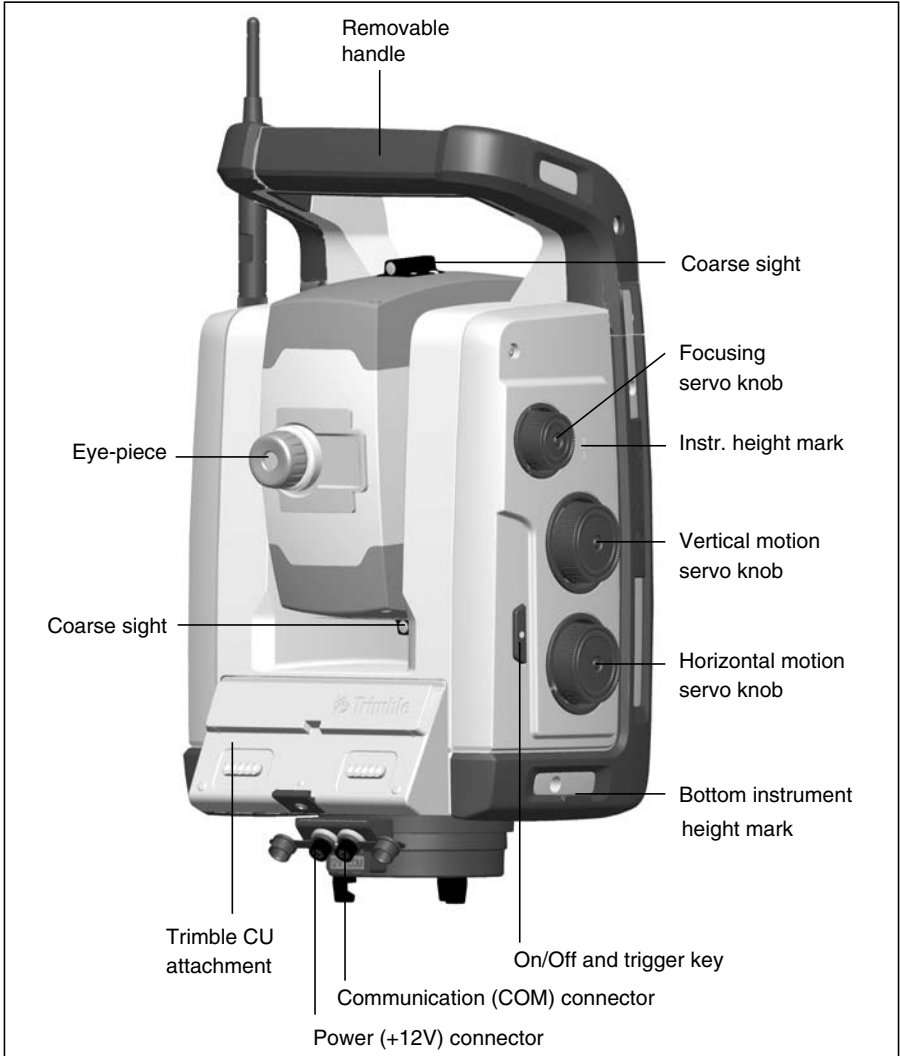

Figure 3.15 Operator's view of the Trimble SPSx30 Total Station

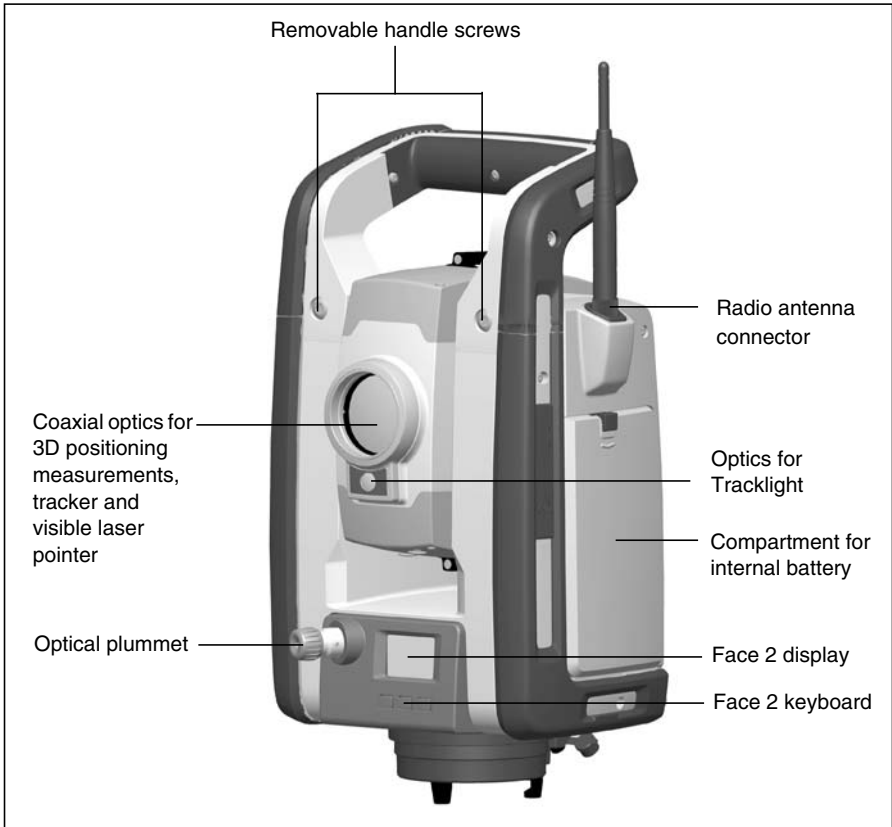

Figure 3.16 Front view of the Trimble SPSx30 Total Station

On/Off Key

When there is no Trimble CU attached to the instrument, the On/Off key will initialize the instrument. An LED in the On/Off key indicates if the instrument is turned on. A solid light indicates on and a flashing light indicates suspend mode.

Face 2 Display

The face 2 display is a graphical display with a built-in backlight, and three control buttons. See figure 3.17

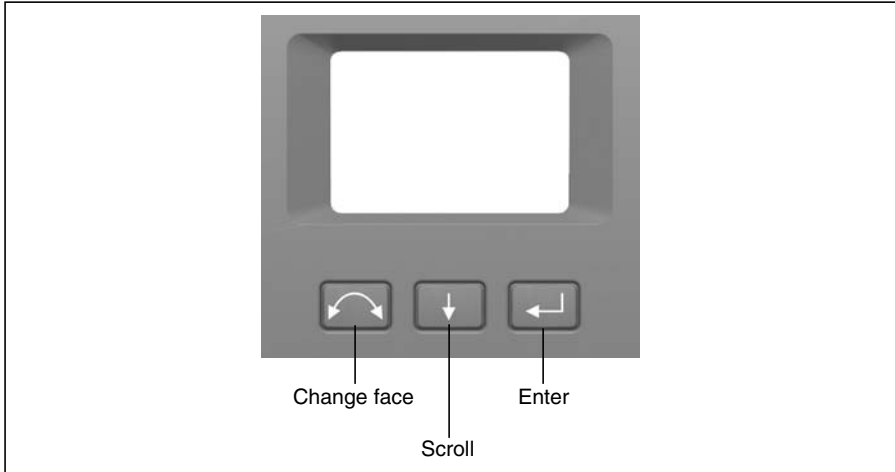

Figure 3.17 Face 2 display and keyboard

When a secondary function is available on a button, an icon appears at the bottom of the display. To access the secondary function, press and hold the appropriate key.

When a Trimble CU is attached to the instrument, the software running on the unit controls the face 2 display and keyboard, and determines which secondary functions are available. For details on how the software controls the face 2 display, refer to the field software documentation.

When there is no Trimble CU attached to the instrument, and you turn on the instrument using the On/Off key, the face 2 display shows an electronic leveling screen. See figure 3.18

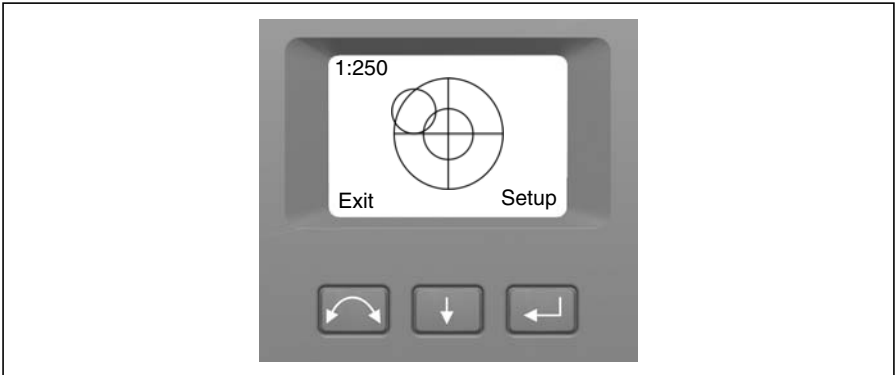

Figure 3.18 Electronic leveling screen on the face 2 display

For information on how to access the compensator menu and instrument setup menu from the face 2 display and keyboard. See Instrument Setup on page 41.

Optical Plummet

The instrument is equipped with an optical plummet, which has 2x magnification and a focusing range of 0.5 m to infinity. The instrument can be positioned to an accuracy of 0.5 mm at 1.5 m over a ground mark.



Figure 3.19 Optical plummet

As shown in figure 3.19:

- To focus the crosshairs, rotate the eye-piece.
- To focus the optical plummet to the ground, push in or pull out the optical plummet.

For information on how to adjust the optical plummet see Optical plummet adjustment on page 79.

Handle

The handle of the Trimble SPSx30 Total Station instrument is detachable for measurements in confined spaces, or for instances where the handle obstructs the sighting line.

The instrument handle is placed so that it will not obscure measurements in the face 1 position, or restrict plumbing vertically beneath an overhead marker or sighting up a vertical shaft:

The handle can be removed by:

1. Unscrew the two Torx screws securing the handle to the instrument, use a T30 Torx key.
2. Slide the handle horizontally away from the front of the instrument. See figure 3.20 and figure 3.21

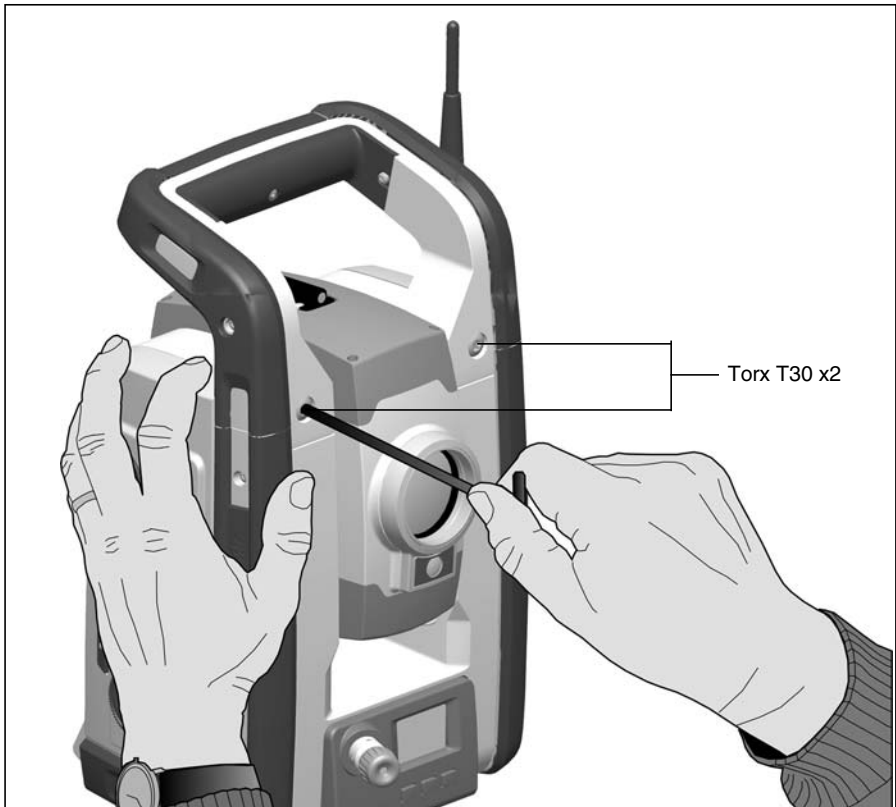

Figure 3.20 Removing the instrument handle



Figure 3.21 Detaching the instrument handle

Attaching the handle:

Attaching the handle is completed by reversing the above operations.



Caution – Make sure that the handle is firmly attached before you lift the instrument.

Laser and LED Information

For more information, See Laser Safety on page v.

Trimble SPSx30 DR Plus Total Station

The Trimble SPSx30 DR Plus Total Station has been tested, and complies with the regulations for a Class 1 and Class 2 Laser product, see figure 3.22.



Figure 3.22 The Trimble SPSx30 DR Plus Total Station

The laser pointer warning label is on top of the distance measuring unit. See figure 3.23



Figure 3.23 Location of the laser pointer warning label on a Trimble SPSx30 DR Plus Total Station

figure 3.24 shows the Laser pointer warning label.



Figure 3.24 Laser pointer warning label

Setup

In this chapter:

- Setup
- Starting the Instrument
- Leveling
- Instrument Setup
- The Laser Pointer
- Measuring the Instrument Height
- Pre Measurement Check List
- Attaching the Trimble CU/Face Plate Cover
- Detaching the Trimble CU/Face Plate Cover
- Connecting a TSC3
- Lifting the Instrument

Setup

An instrument setup with good measuring stability will increase the precision in the measurement result and allow you to utilize the measurement precision of the Trimble SPSx30 Total Station to its full extent.

Setup Stability

When an instrument is setup it is important to consider the following:

1. Set tripod legs wide apart to increase the stability of the setup. A setup where one leg is placed on e.g asphalt and the other two on soil will still be a stable setup provided that the tripod legs are set wide enough. If it is not possible to set the tripod legs wide apart due to obstacles, then the tripod can be lowered to increase stability.

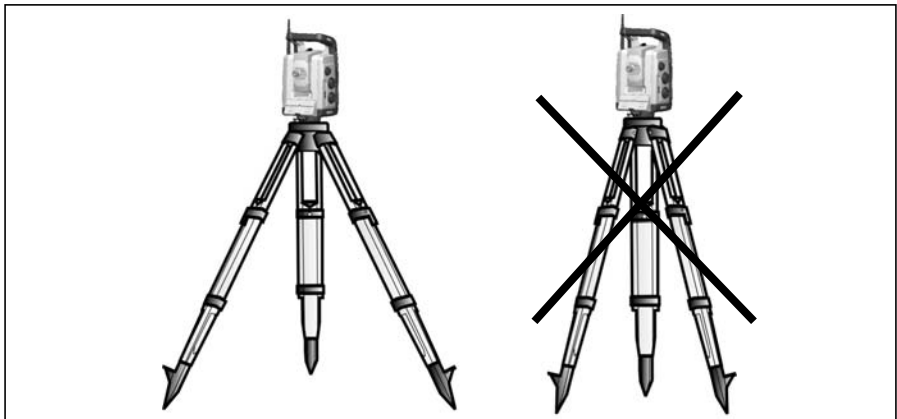

Figure 4.25 Correct instrument set up

2. Make sure that all the screws on the tripod and/or tribrach are tightened to avoid any play.
3. Any high quality tripod and tribrach can be used. However, Trimble strongly recommends the use of tripod heads made of steel, aluminium or similar material. Tripod heads of fiberglass or other composite materials are not recommended.

See Servo Technology on page 106 for more information.

Measurement Stability

Take into account that instruments require sufficient time to adjust to the ambient temperature. The following rule-of-thumb for a high precision measurement applies: Temperature difference in degree Celsius ($^{\circ}\text{C}$) $\times 2 =$ duration in minutes required for the instrument to adjust to the new temperature.

Avoid sighting across fields with intense heat shimmer by sun light, e.g. at noon.

Starting the Instrument

Note – Before following any of the instructions below, put the instrument in the face 2 position, i.e. the telescope eyepiece and face 2 keyboard and display are pointing towards you.



The face 2 display menus described in this chapter can only be accessed when there is no Trimble CU attached, please remove the Trimble CU before starting the instrument.

Start the instrument by pressing the trigger/on/off key.

Once you start the instrument, the *Select Mode menu* appears in the face 2 display.

If no key is pressed for more than 10 secs, the instrument will return to *Waiting for connection* screen displaying the selected radio **Channel** and **Network ID**



To go to setup & level press  to scroll to **Setup/Level** and then press .

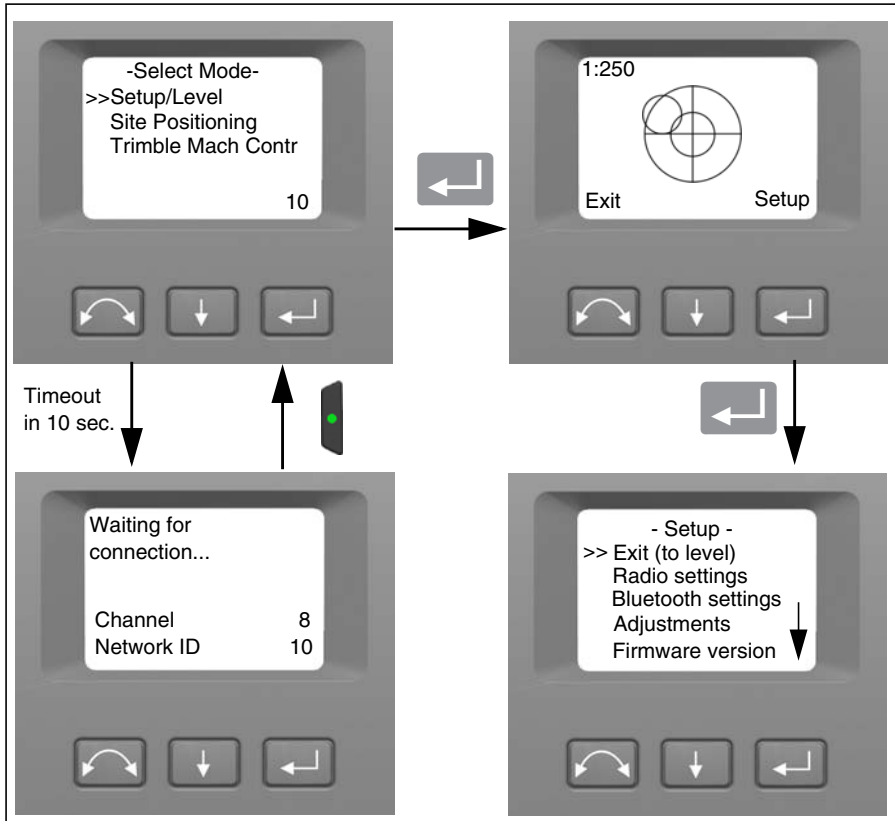

From this menu you can set up the remote operating modes Site Positioning or Trimble Machine Control.

If the instrument is in suspend mode for either Site Positioning or Machine Control mode, you can change the selected mode of operation by returning to the instrument, tap the trigger/on/off key and select the desired mode of operation i.e. to change from Site Positioning mode to Trimble Machine Control Mode.

Site Positioning Mode:



In this mode, the instrument operates with a slower data update rate and is not fully optimized for dynamic positioning applications. This mode is suited to measurements while standing still or walking and measuring with DR reflectorless capabilities.

Trimble Machine Control Mode:

In this mode the angle and distance measurements are fully synchronized and the latency of the data is very low and well controlled. Radio jitter is almost entirely eliminated. The combination of all these functions delivers greater precision measurement to fast moving targets. In this mode, the search functions are also optimized for trajectory prediction, and reacquisition to a target while moving. While in suspend mode, the instrument can also be setup using the SCS900 software to sequentially scan multiple radio channels and addresses, so that the instrument can be used to serve multiple machines on request, all operating on different channels. The Machine Control mode should be used for all machine control operations and is used by the SCS900 vehicle mode of operation.

Note – SCS900 allows the user to set up a series of users in a list, stored in the instrument memory. Each user in the list has its own radio channel and network ID allocation. While in suspend mode for Machine Control, the instrument will sequentially scan the radio channel and address for each member of the list, and additionally the last Site Positioning user. Through this process the instrument makes itself available to any user wanting to use it. Once a user has established connection with the instrument, all other users are locked out until the instrument is relinquished by the live user.

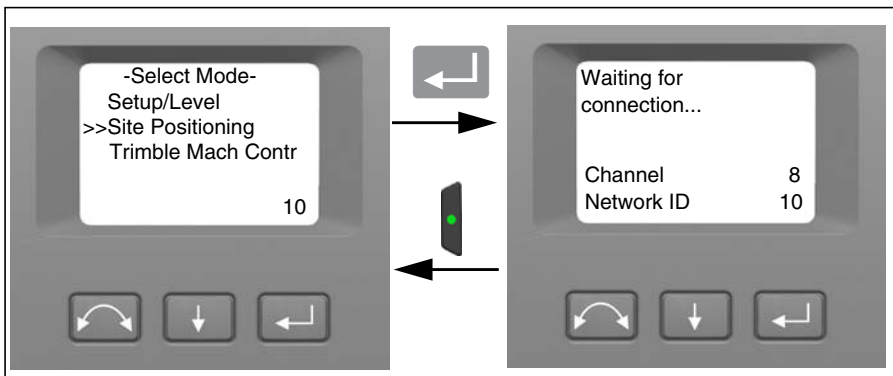

The current mode of operation can be broken by returning to the instrument and tapping the trigger/on/off key. This process will terminate any live user and make the instrument available. Trimble strongly advise that this process be used only when absolutely necessary, so as not to disrupt machine control operations on a project.

To set up the instrument for Site Positioning, press  to scroll to Site Positioning and then press .



After the selection the instrument will go to suspend mode, to return to the *Select Mode* menu press the trigger/on/off key.

The instrument is now setup for Site Positioning with the radio set as base station.

To set up the instrument for Trimble Machine Control, press  to scroll to Trimble Mach Contr and then press .

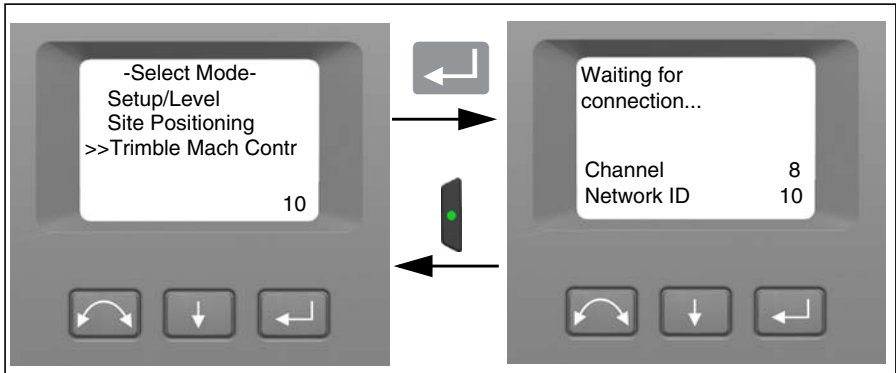

After the selection the instrument will go to suspend mode, to return to the *Select Mode* menu press the trigger/on/off key.

The instrument is now setup for Trimble Machine Control with the radio set as remote station.

Note – If no selection is made within 10 seconds the instrument will go to suspend mode. To return to the *Select Mode* menu press the trigger/on/off key

Note – If no selection is made the last highlighted mode will be used.

Leveling

Once you have selected Setup/Level, the face 2 display appears with the electronic bubble for leveling. If there is a Trimble CU attached, the Trimble CU software controls the face 2 display. Figure 4.26 shows the leveling process.

To toggle between a graphical or numerical display make a long press on .

To change the graphical displays sensitivity (zoom) make a short press on .

To accept and enter the *setup* menu press .

Note – Due to the high speed servo it is important to use a high quality tripod and tribrach.

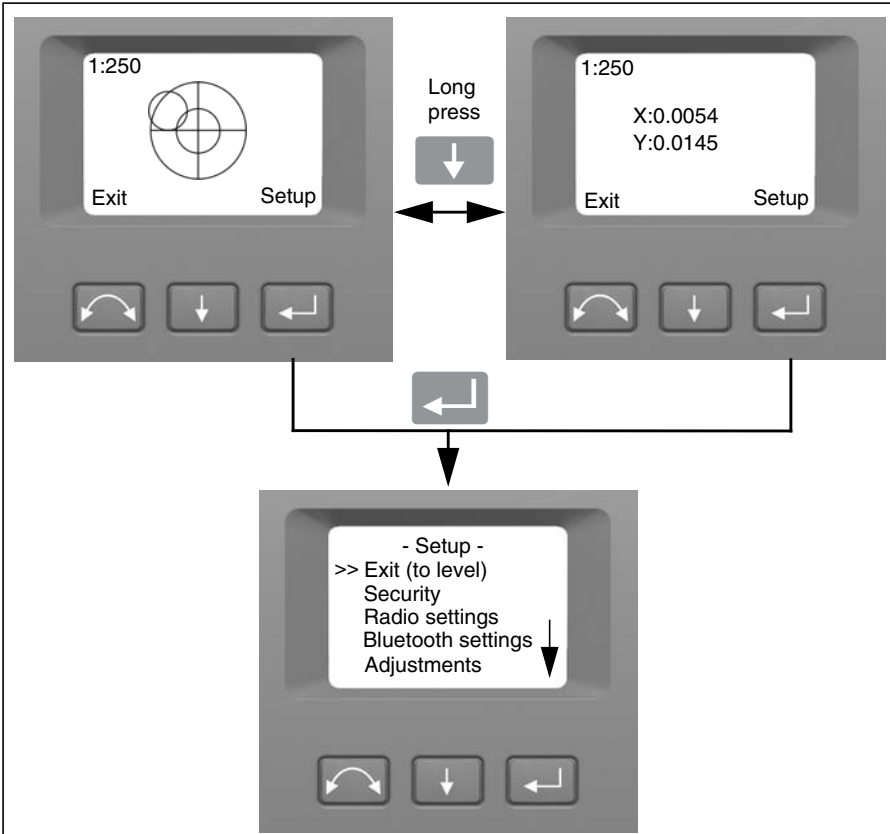



Figure 4.26 The leveling process

Note – If the instrument is inactive for longer than 300 seconds (5 minutes) it will go to suspend mode. See Power Management on page 109

Instrument Setup

With the face 2 display, you can access a number of instrument functions and routines without a Trimble CU attached:

In the leveling display select **Setup** by pressing , the *Setup* Menu appears:

Note – It is possible to access the instrument setup menu without levelling the instrument.

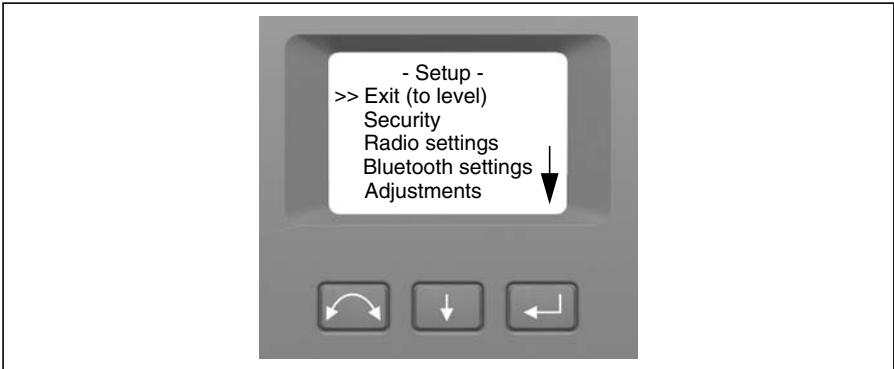

The instrument *Setup* menu is structured as follows:

- Exit (to level)
- Security settings, See Security on page 43
- Radio settings. See page 49.
- Bluetooth[®] settings
- Adjustments. See page 54.
 - Back
 - Compensator calibration. See page 55.
 - HA/VA and trunnion axis collimation. See page 58.
 - Tracker collimation. See page 63.
 - Laser pointer on/off. See page 65.
- Firmware version information. See page 68.
- Language settings

Security

To avoid unauthorized use of the instrument a PIN/PUK security code can be activated by the user.

PIN Code









The PIN Code is a four digit code where each digit can be set between 0-9 e.g. “1234”. The PIN Code can be activated and changed by the user.

As default the PIN Code is set to “0000”. With this code set the security is not activated and the user will not be prompted to enter PIN Code at start up.



Note – If the wrong code is entered more than 10 times, the instrument will be locked and the PUK Code needs to be entered.

Activate or Change PIN Code

To activate the security PIN Code or change the PIN Code:

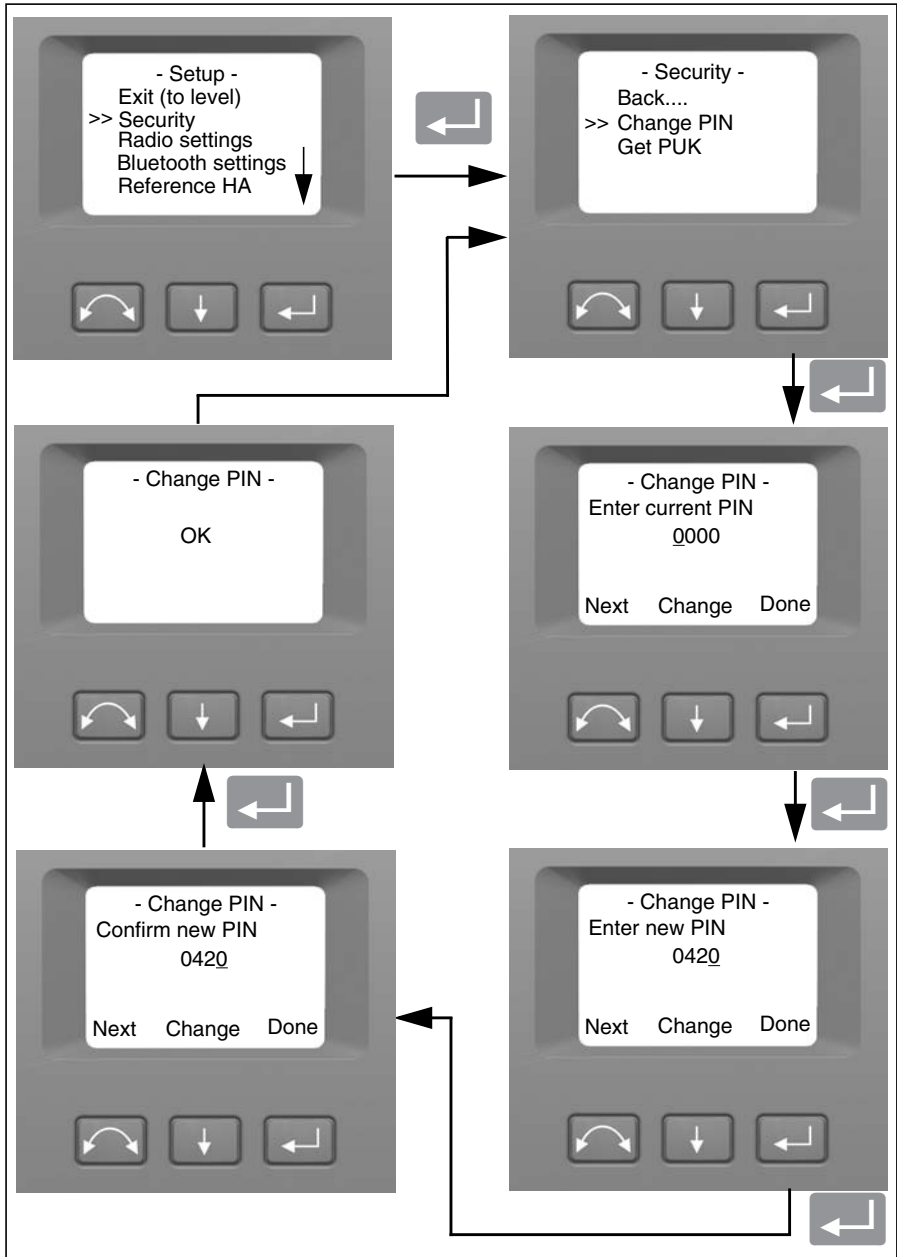
1. Press  to scroll to **Security** and then press .
2. Press  to scroll to **Change PIN** and then press .
3. Enter the current PIN Code. The underlined digit is selected for change.
 - a. Press  to change the digit to the correct number.
 - b. Press  to select the next digit.
 - c. When all four digits have been set to the correct PIN code press .
4. Enter the new PIN Code of your choice and press , follow the instructions 3a, 3b and 3c
5. To confirm the PIN Code press .



6. Press  to scroll to Back... and then press  to return to the Setup menu.

Unlock Instrument With PIN Code

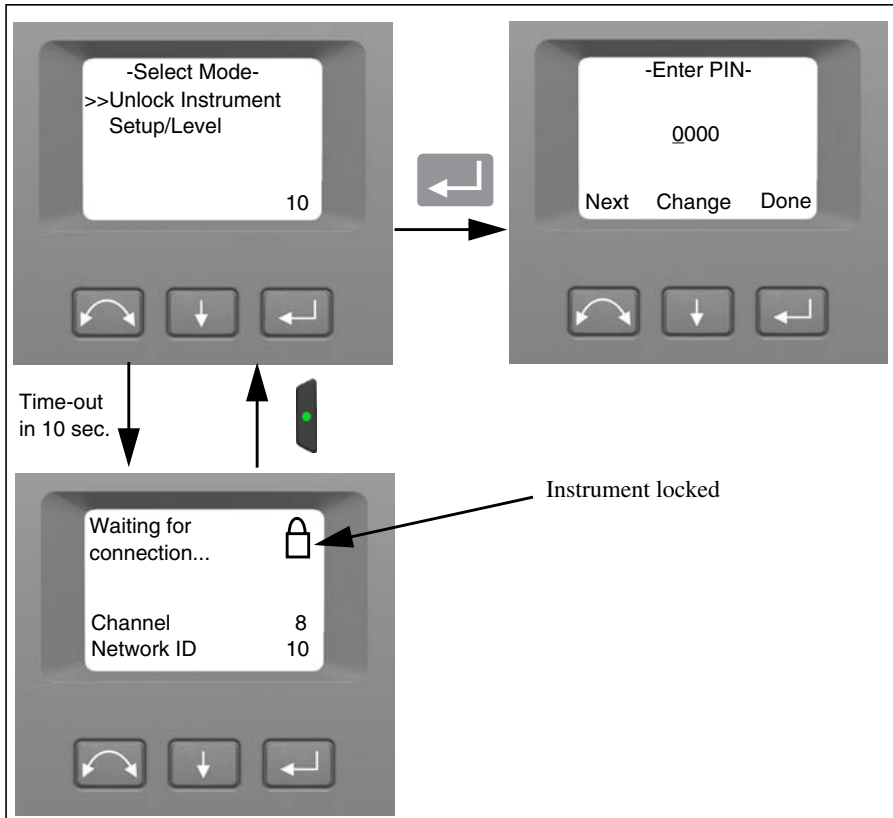

When the security PIN Code has been activated, the PIN Code needs to be entered at start up.

To unlock the instrument select Unlock Instrument and press .



Note – If no selection is made within 10 seconds the instrument will go to suspend mode. To return to the select mode menu press the trigger key.

The PIN code is a four digit number. The underlined digit is selected for change.

1. Press  to change the digit to the correct number
2. Press  to select the next digit.
3. When all four digits have been set to the correct PIN code press .

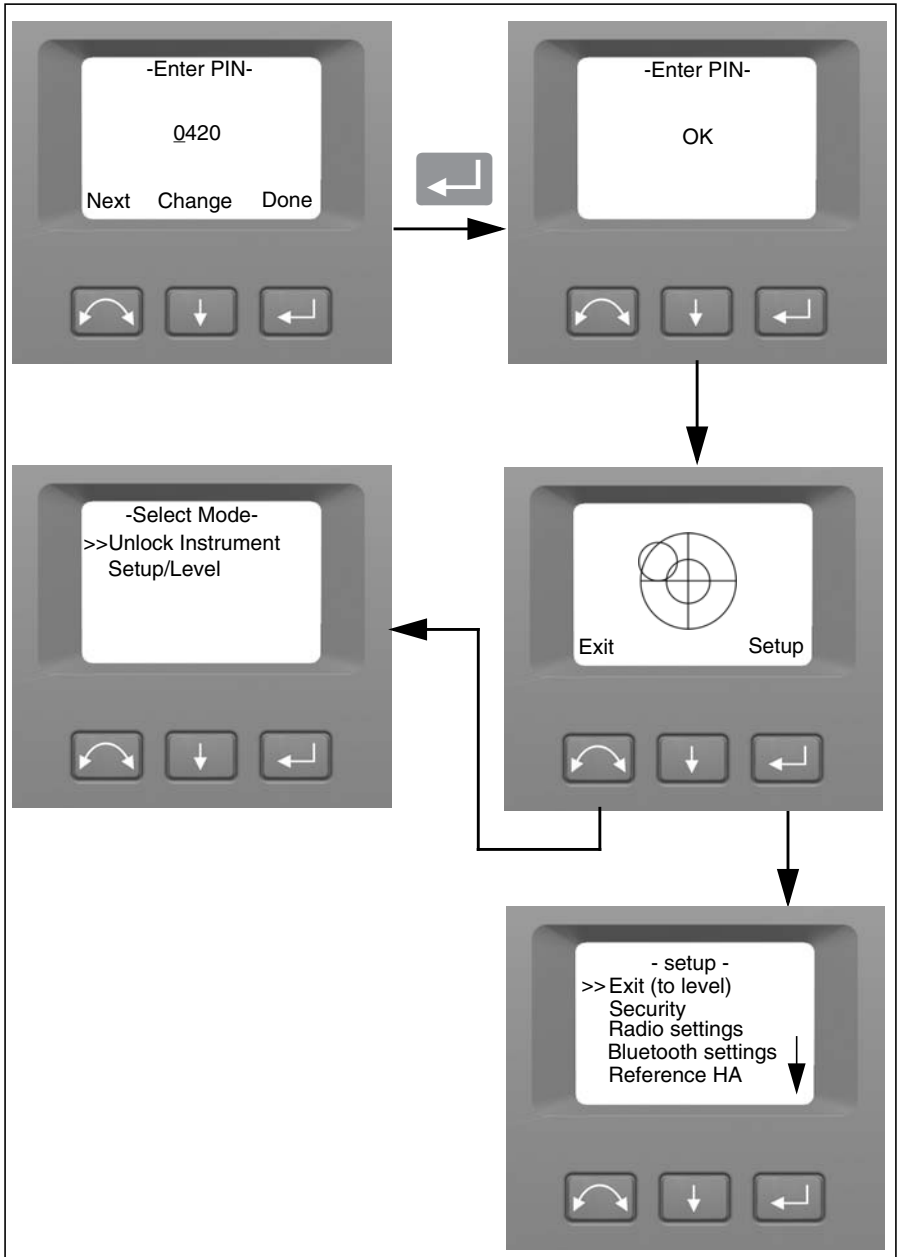

If the wrong PIN Code is entered more than ten times, you will be prompted to enter the PUK Code.

When the correct PUK Code has been entered, the PIN Code will be reset to “0000”. This means that the PIN Code security will be inactivated.

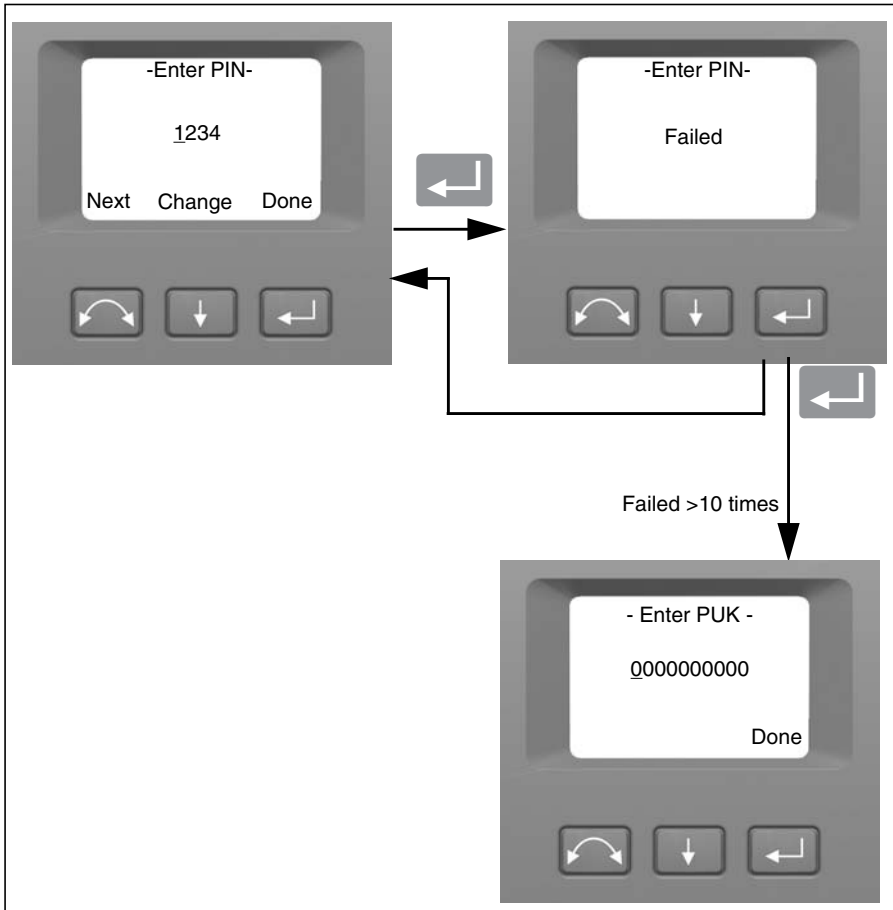

PUK Code





The PUK Code is a ten digit code where each digit is set between 0-9 e.g. “0123456789”. The PUK Code can not be changed by the user.

The PUK Code is set at the factory. A document with the PUK Code is supplied to the user when the instrument is delivered. Please save this document in a safe place.

Note – If the PUK code has been lost, please contact your authorized Trimble distributor to retrieve the PUK code.

Note – The PUK Code is needed to unlock the instrument if wrong PIN Code has been entered more than ten times.

You can read out the PUK Code from the instrument:

1. Press  to scroll to Security and then press .
2. Press  to scroll to Get PUK and then press .
3. Press  to return to the Security menu.

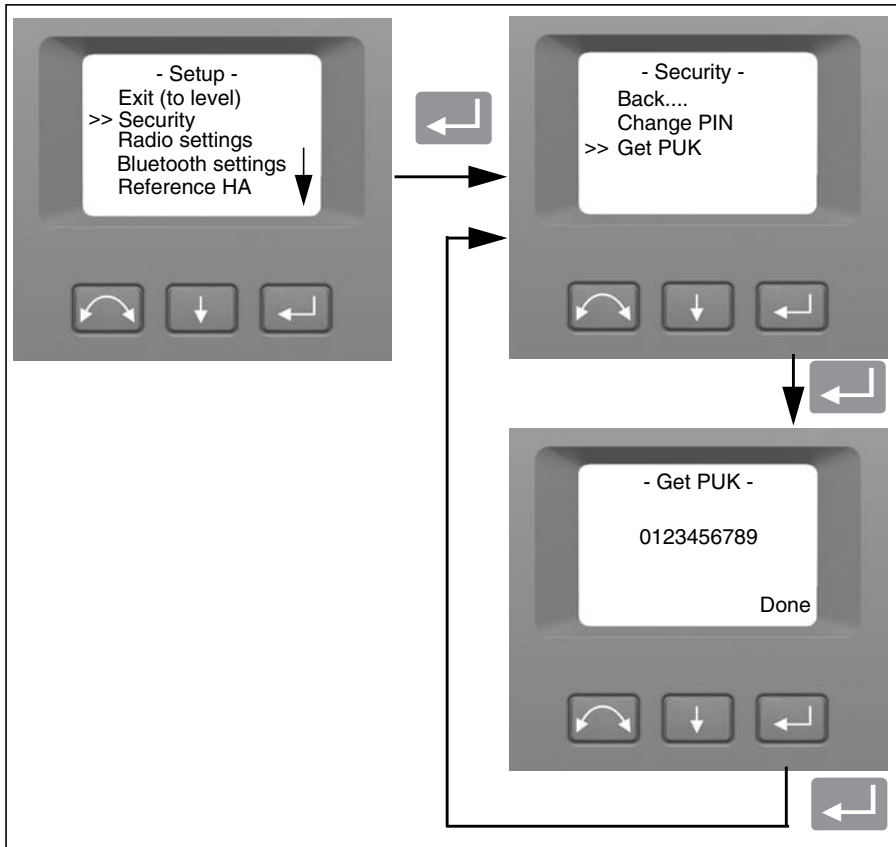





Radio Settings

In the *Radio settings* menu it is possible to set the radio channel and network ID number.

Note – The radio channel and network ID for machine control & Machine Guidance use must be set using the Trimble SCS900 software. These can not be set from the face 2 display.

Set Radio Channel

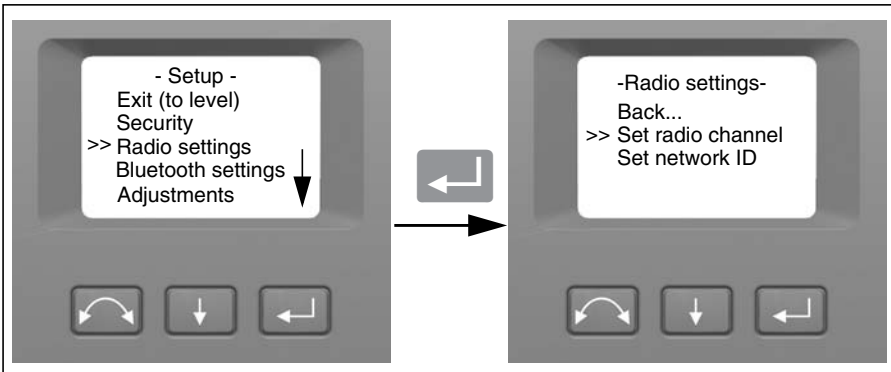

1. Press  to scroll to Radio settings and then press .
2. Press  to scroll to Set radio channel and then press .





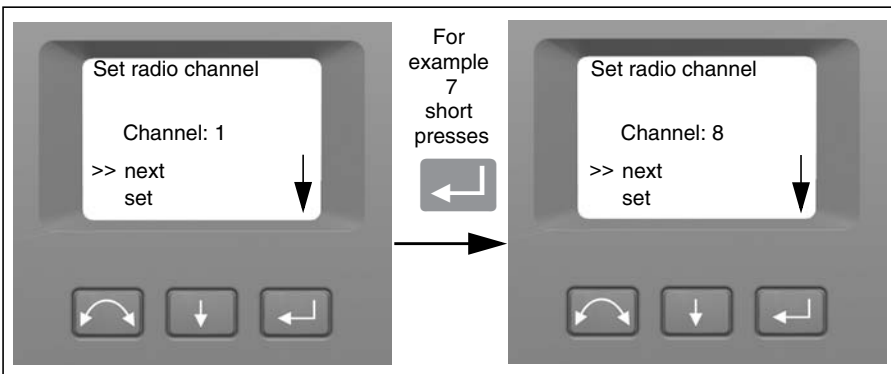

3. To change the radio channel number press  to select Next and then press  to change the channel number in the display.

Note – a short press on the enter key will increment the radio channel in increments of 1, pressing and holding the enter key, will increment the radio channel in steps of 10.

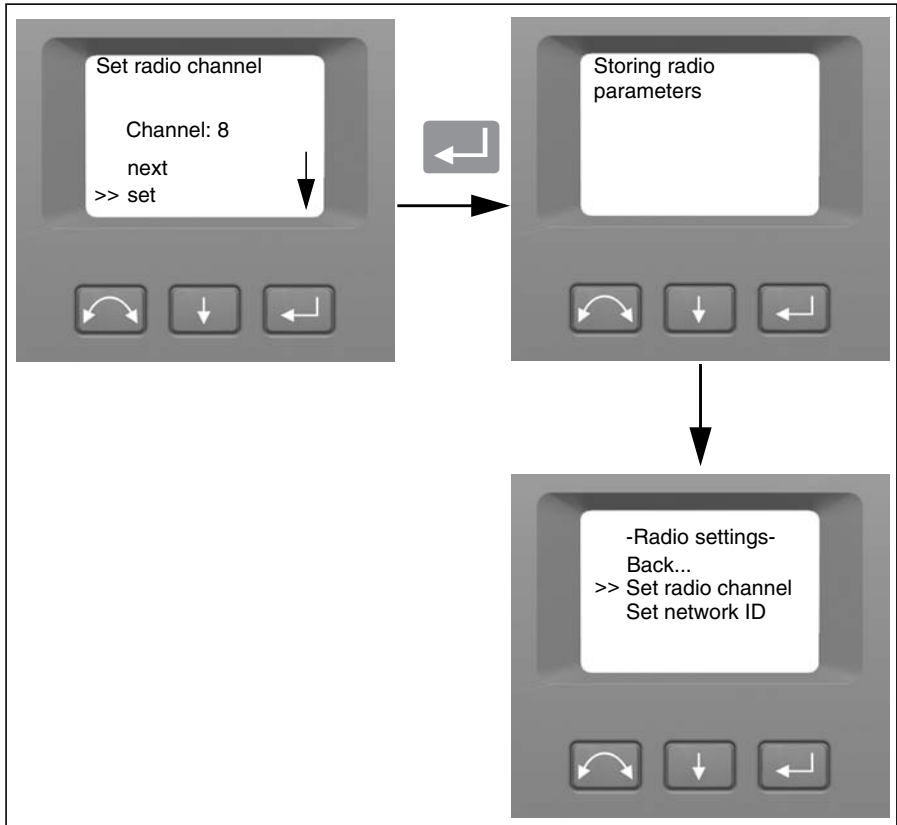

- When you have found the channel number of your choice press  to select **Set** and then press  to store this channel number. You will then be returned to the **Radio Settings** menu.







- If you want to cancel press  to select **Cancel** and then press  to return to the **Radio Settings** menu.
- To return to the *Setup* menu press  to scroll to **Back** and then press .

Each combination of channel and network ID is unique, however try to keep each SPS system on a separate radio channel to avoid any likelihood of conflict.

Note – The instrument and machine or instrument and robotic rod have to have the same radio channel and network ID for communication over radio to take place.

Set Network ID

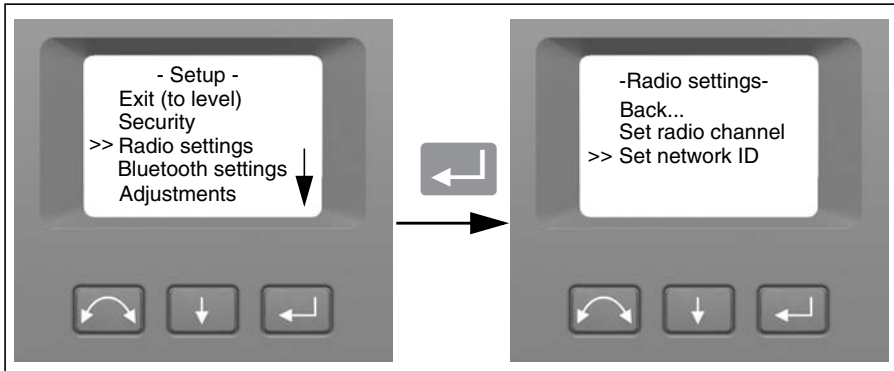

1. Press  to scroll to Radio settings and then press .
2. Press  to scroll to Set network ID and then press .

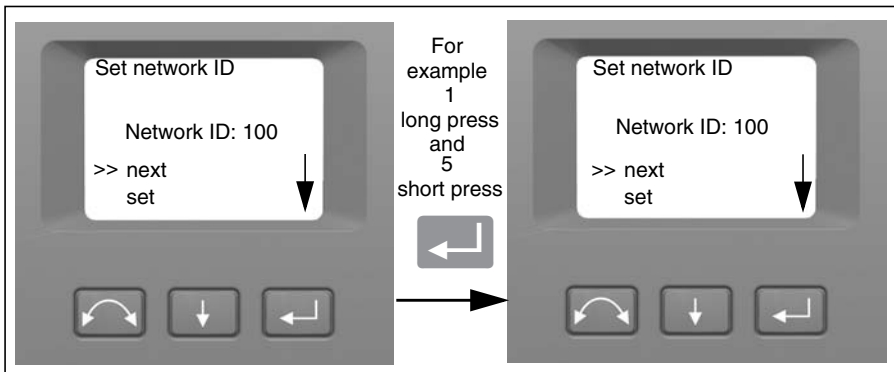

3. To change the network ID number press  to select Next and then press  to change the channel number in the display. The available network ID range is 0-255

Note – a short press on the enter key will increment the network ID in increments of 1, pressing and holding the enter key, will increment the network ID in steps of 10.



4. When you have found the network ID number of your choice press  to select Set and then press  to store this network ID number. You will then be returned to the Radio Settings menu.

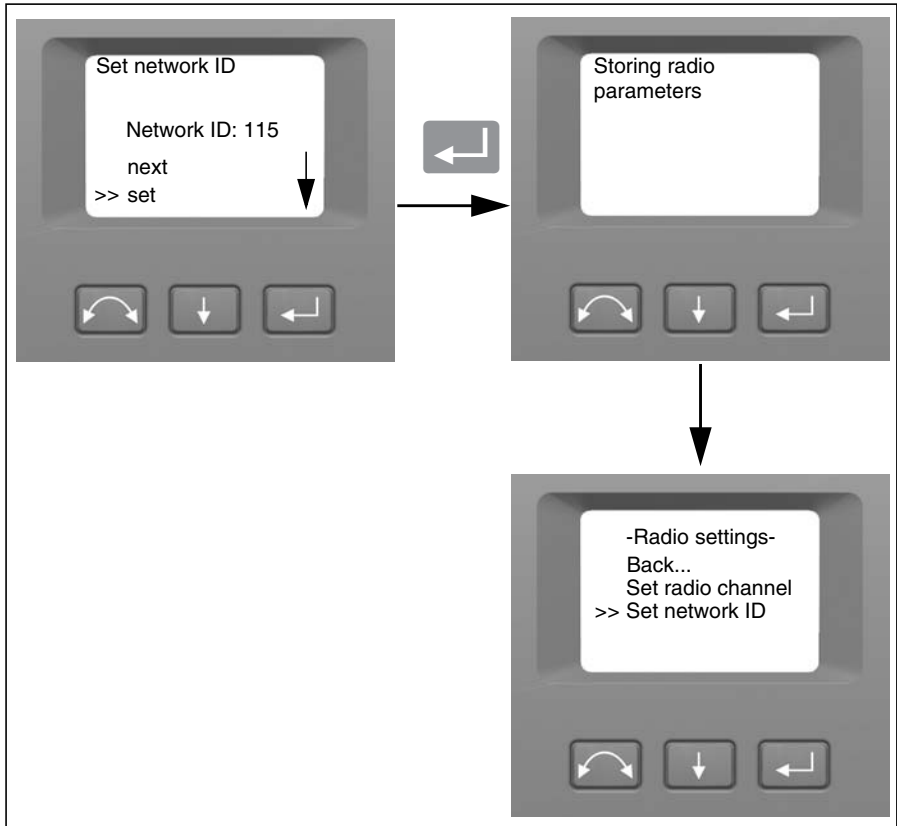

5. If you want to cancel press to select **Cancel** and then press to return to the **Radio Settings** menu.
6. To return to the *Setup* menu press to scroll to **Back** and then press .



Each combination of radio channel and network ID is unique, however try to keep each SPS system on a separate channel to avoid any likelihood of conflict.

Note – *The instrument and machine or instrument and robotic rod have to have the same radio channel and network ID for communication over radio to take place.*

Bluetooth® Settings



All Trimble SPSx30 Total Station instruments are equipped with Bluetooth wireless technology for cable free operations and connection to an external controller when operating in Servo, Autolock or DR Reflectorless modes. The Bluetooth antenna is located directly beneath the controller attachment plate in the face 1 position. In order to facilitate communications between a TSC3 controller or Tablet computer and the Trimble SPSx30 Total Station instruments, first enable the Bluetooth wireless technology option in the instrument. This is carried out as follows.

Caution – Before starting the Bluetooth device, make sure that the regulations of the country that you are working in allows the use of Bluetooth wireless technology.

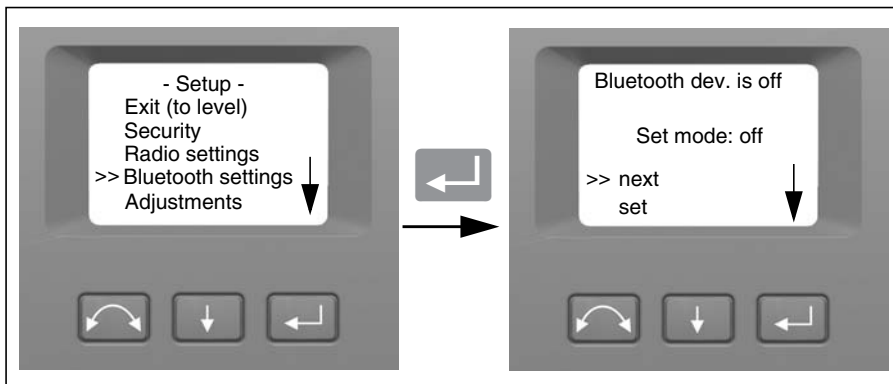

1. Press  to scroll to Bluetooth settings then press .



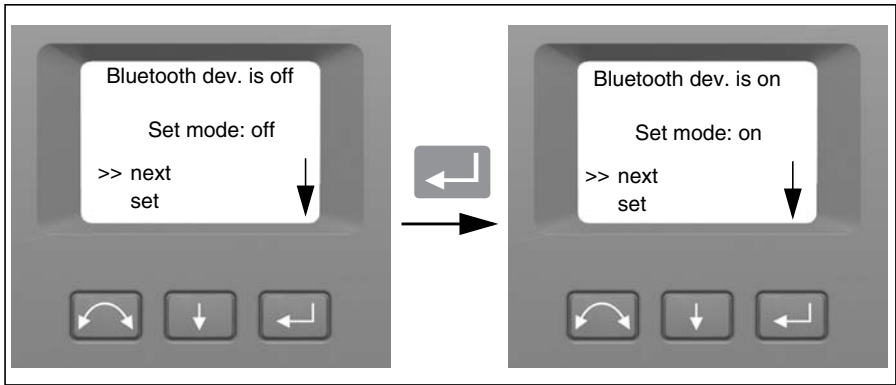

4 Setup

- To change the Bluetooth setting press  to select **Next** and then press  to select **on** or **off**

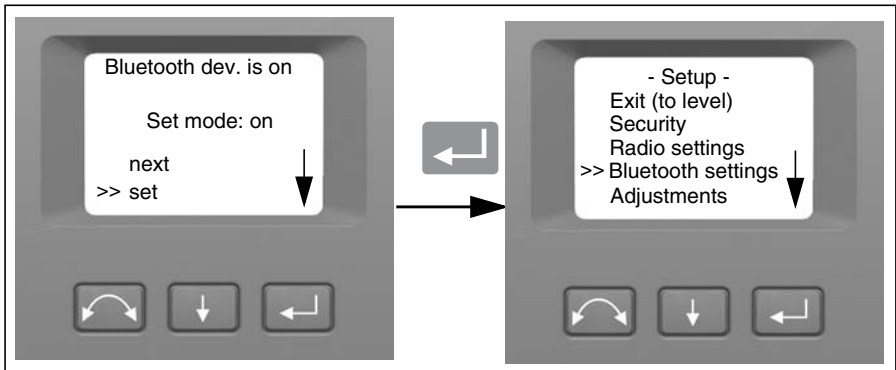

- When you have found the setting of your choice press  to select **Set** and then press  to store this setting. You will then be returned to the **setup** menu.





- If you want to cancel press  to select **Cancel** and then press  to return to the **setup** menu.

Note – At delivery the Bluetooth device is by default in off mode. Any change to this setting made by an operator will become the default setting until changed again.

Note – To reduce power consumption and extend operation time, Trimble recommends that the Bluetooth device is switched off when not in use.

Adjustments Menu

The *adjustments* menu contains all the instrument collimation and calibration routines.

- Press  to scroll to Adjustments and then press .

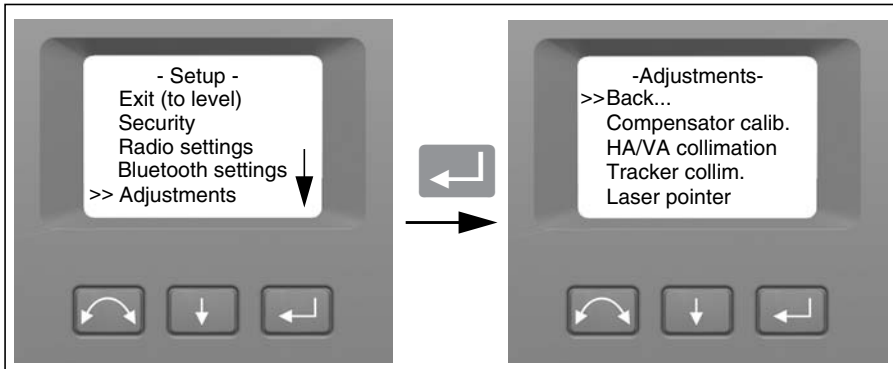

Compensator Calibration



The SPSx30 Total Stations are all equipped with a dual axis compensator. The compensator is active when the instrument is switched on. The compensator should be calibrated periodically, to adjust for any minor changes in the instrument caused by normal wear and tear, shipping or temperature variations.

To calibrate the compensator, the instrument needs to be in perfect balance. After calibration the compensator sensor will automatically adjust and allow for changes in that balance caused by the presence of a Trimble CU controller or the absence of an internal battery.

To minimize imbalance in the instrument:

- Do not have the Trimble CU mounted on the instrument.
- An internal battery must be present in the battery compartment.
- The instrument handle must be attached.
- The instrument will automatically position the telescope and distance unit for best balance.

To start the compensator calibration:

1. Level the instrument. The instrument will automatically check if the compensator is within range before the calibration is started.
2. Press  to scroll to **Compensator calib.** and then press .
3. Follow the instructions in the display. Figure 4.27.

Note – Trimble recommends that you regularly carry out a compensator calibration, particularly when measuring during high temperature variations and where the highest measurement accuracy is required.

Note – If a compensator calibration has been performed, Trimble recommends you carry out an HA/VA and Tracker Collimation. Performing a compensator calibration makes the previously stored values from the last HA/VA and Tracker collimation irrelevant, so it is imperative that you carry out these collimations each time you do a compensator calibration.

The calibration process involves the instrument automatically reading the compensator value at a series of predetermined positions through the full rotation of the instrument. The process takes approximately one minute to complete. During the process the instrument should be on a stable platform, free from vibration and untouched by the user.

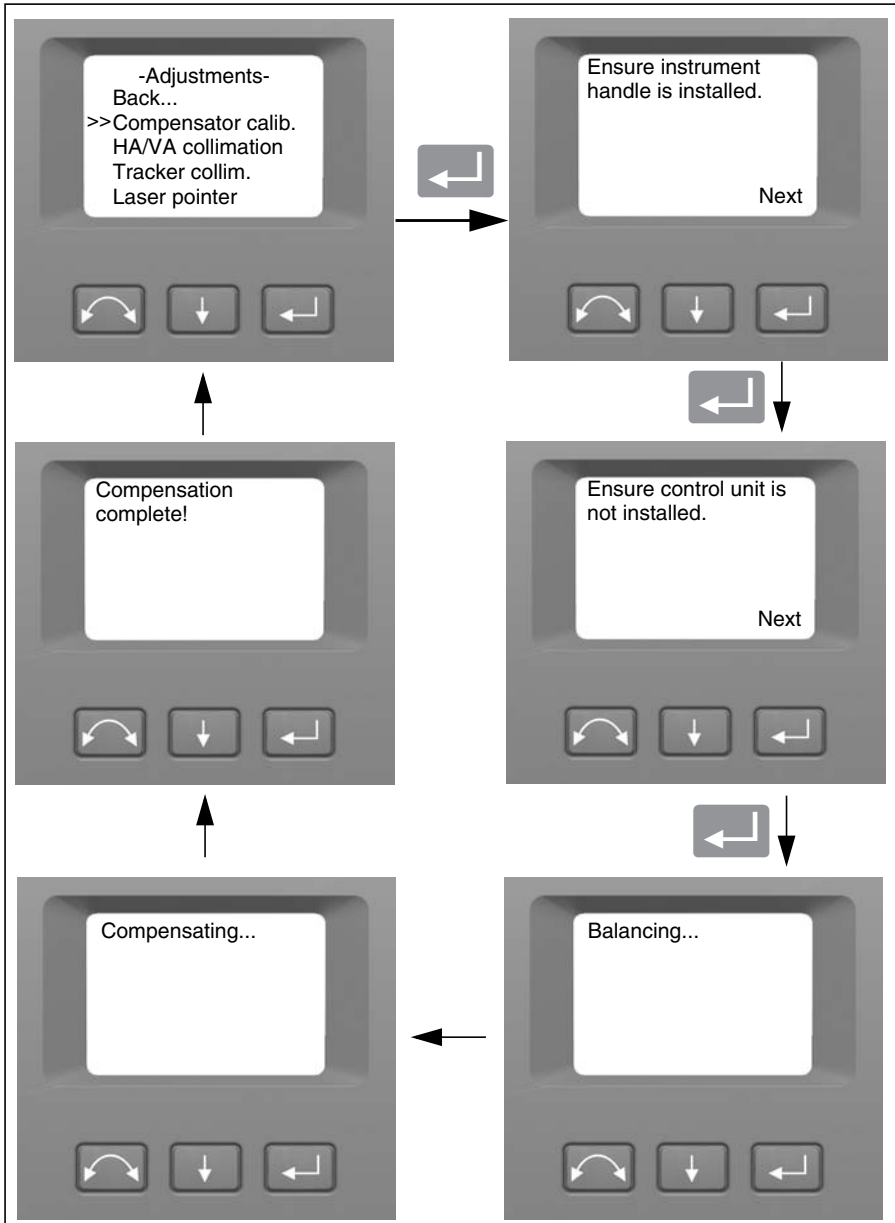

Figure 4.27 Compensator calibration routine

HA/VA Collimation and Trunnion Axis Tilt

The Trimble SPSx30 Total Station instrument utilizes precise angle and distance measurements to determine the 3D position of the point being measured. The instrument's design facilitates the ability to measure all points with a single pointing to the target in the face 1 position. All electronic total stations are subject to collimation errors in both the horizontal and vertical angle measuring systems, and also errors caused by the axis of the telescope not being truly perpendicular to the vertical of the instrument.

In order to compensate for these errors, the collimation routine allows the operator to accurately determine the current errors in the instrument, and store the errors as corrections to be applied to all measurements made in a single pointing to a target. In this way the Trimble SPSx30 Total Stations will always provide accurate 3D positions:

The Collimation errors and Trunnion axis tilt will change over time, the most common changes being caused by

- Wear and tear with use
- Bumps and knocks during transit
- Large changes in operating temperature

Trimble recommends that a HA/VAcollimation check and tilt axis check be carried out routinely as follows:

- After any long uncontrolled transport of the instrument (e.g. after service or shipment to a new location)
- After any accidental knock or drop
- At any time when the operating temperature changes by more than 10°C (18°F)
- At any time when the instrument changes it's height above sea level by more than 500m (1640 Feet)
- At any time when the highest accuracy positions are required
- Routinely on a periodic basis (Monthly, weekly etc.)
- Anytime a compensator calibration is performed

Trimble also recommends that the operator keep a record of the dates and values measured so that any gross changes can easily be detected. Gross changes can indicate the need for a check by an approved service center.

When carrying out collimation error checks using the Trimble CU and SCS900 software, Trimble recommends that the user maintain a Site and Work Order in the SCS900 system especially for the purpose of tracking the instrument calibration process. SCS900 will store the new collimation and trunnion axis tilt values within the currently open work order. Maintaining a log of all instrument checks, helps QA and QC processes over the lifetime of the instrument.

The adjustment of the instrument for HA/VA collimation and Trunnion Axis tilt is a two stage process.

The Horizontal and Vertical collimation and the trunnion axis tilt correction have been measured and stored in the instrument at the factory.



In all calibrations, multiple sightings will be made in both faces to ensure that any minor pointing errors can be eliminated in the accurate determination of current collimation error values.

In a new instrument the values should be close to zero, over time these will change. The instrument allows a maximum value of 0.05 grads (0.045 degrees) in the HA, VA and Trunnion axis tilt values. If these values are exceeded, the instrument will need service to rectify a mechanical problem.

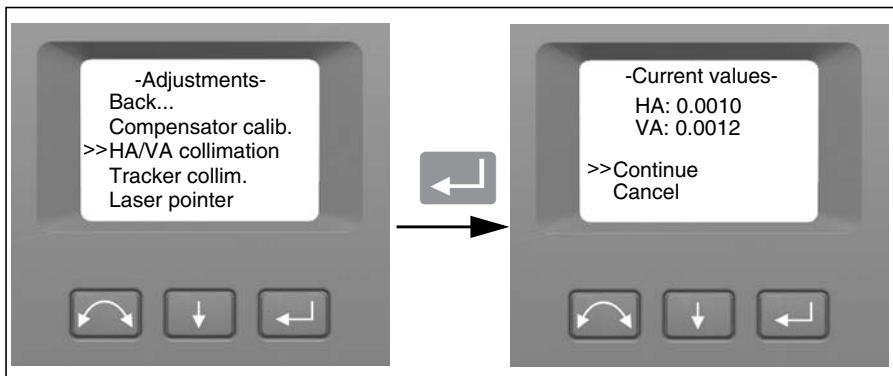
1. Press  to scroll to HA/VA collimation and then press .



The current collimation values appear.

2. Press  to scroll to one of the following:
 - Continue Then press  to continue the HA/VA collimation test.
 - Cancel. Then press  to return to the Adjustments menu.

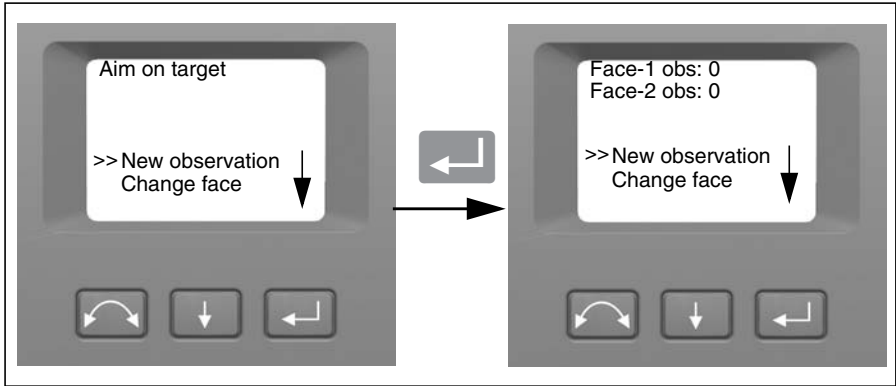

If you select Continue:

3. Press to scroll to one of the following:
 - New observation. Then press to continue the HA/VA collimation test.
 - Change face. Then press to change between face 1 and 2.
 - Cancel. Then press to return to the Adjustments menu.

If you select New observation:

- d. Aim accurately in face 2 towards a point near the horizon at max. ± 5 grads (± 4.5 degrees) to the horizontal and at a minimum distance of 100 m (328 ft.).
- e. Press to scroll to New observation. Then Press to measure and record a pointing.
- f. Re sight the instrument at the same point and press the enter key again. Repeat this process for a minimum of 3 sightings in face 2.
- g. Press to scroll to Change face. Then press to change to face 1.
- h. Aim accurately towards the same point as that used in face 2.
- i. Press to scroll to New observation. Then Press to measure and record a pointing.
- j. Re sight the instrument at the same point and press the enter key again. Repeat this process for the same number of times as in face 2.



As observations are made on the first face (either face 1 or face 2), the angle values are stored and the counter increases. When one or more observations have been taken on each face, and the number of observations on each face are the same, the software calculates and displays the new horizontal and vertical collimation values.

4. Press to scroll to one of the following:
 - Trunnion coll. Then press to continue to Trunnion collimation.
 - Store correction. Then press to accept and store the new collimation values.

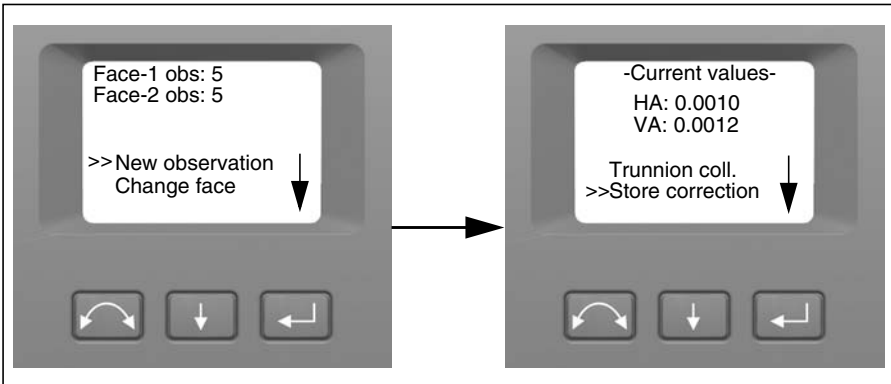
- Cancel. Then press  to return to the adjustments menu.



Select Trunnion coll. to continue with trunnion axis tilt collimation.

5. Press  to scroll to Trunnion coll. Then press  to continue the Trunnion axis tilt test.

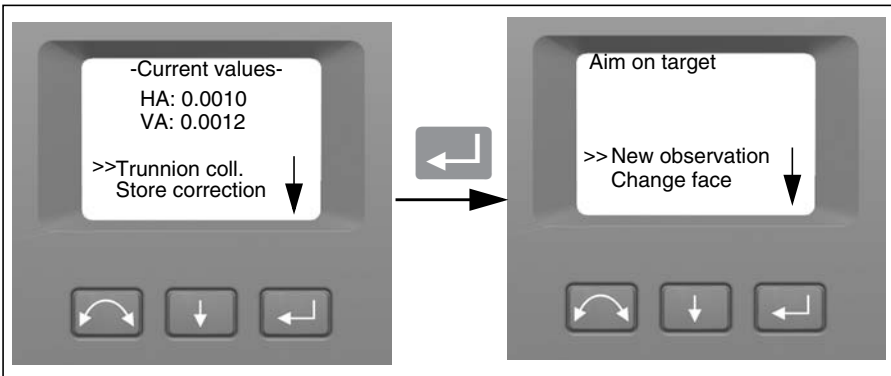

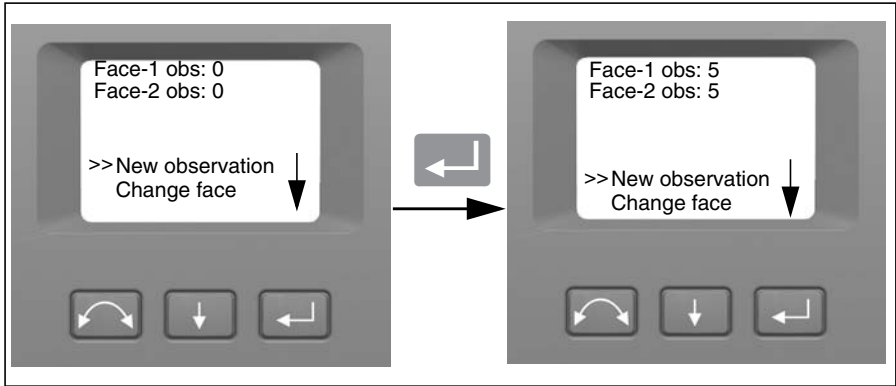

6. Press to scroll to one of the following:
- **New observation.** Then press to continue the trunnion axis tilt test.
 - **Change face.** Then press to change face.
 - **Cancel.** Then press to return to the adjustments menu.

If you select **New observation** the number of observations in both faces appears:

- a. Aim accurately in face 2 towards a point at least 15 grads (13.5 degrees) above or below the point where the collimation test was made at a minimum distance of 30 m (66 ft.).
- b. Press to measure and record angles.
- c. Press to scroll to **Change face**. Then press to change face.
- d. Aim accurately towards the point.
- e. Press to measure and record angles.

As observations are made on the first face (either face 1 or face 2), the angle values are stored and the observation counter increases. When one or more observations has been taken on each face, and the number of observations on each face are the same, the software calculates and displays the new trunnion axis tilt value.

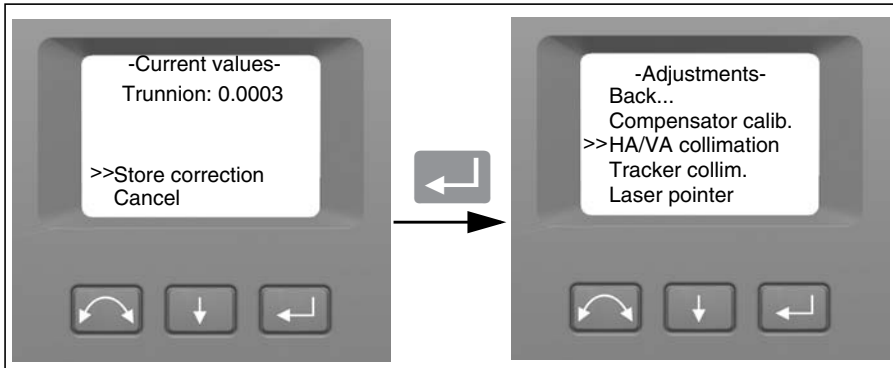

7. Press to scroll to one of the following:

- Store correction. Then press to accept the new trunnion axis tilt value. The Adjustments menu appears.
- Cancel. Then press to return to the Adjustments menu.

Note – The instrument will prohibit a trunnion axis tilt test if it is made towards a point with an angle less than 15 grads (13.5 degrees) from the point where the collimation test was made. The trunnion axis tilt determination accuracy will improve with a steeper angle towards the measured point. The minimum distance for the trunnion axis tilt measurement is 30 m (66 ft.).

Note – If the trunnion axis tilt correction value is greater than 0.05 grads (0.045 degrees), the message *Fail Remeasure?* appears. Press Yes and then repeat the measurement procedure. If the value is greater than 0.05 grads (0.045 degrees) and you answer No to the re measurement message, the instrument uses the correction value previously stored in the instrument. If the value is greater than 0.05 grads (0.045 degrees), then the instrument must be mechanically adjusted at the nearest authorized Trimble service center.

Tracker Collimation

The instrument tracker unit is designed to be coaxial with the instrument cross hairs. For this reason a tracker collimation check needs to be carried out on a regular basis (under the same conditions as the HA/VA collimation check) to ensure that any slight misalignment is corrected for.



Perform the test over a similar distance as that you will be working on, but at least 100 m.

The prism target must be very still during the test (Trimble recommends that you use a tripod or bipod mount for the target) and must be in clear line of sight without any obstructing traffic. The instrument is calibrated to accurately point at the center of the target in both horizontal and vertical axes. The calibration is used to correct the positions of all points measured using the tracker function. The measured calibration values are stored and used until a new set of calibration values are determined.

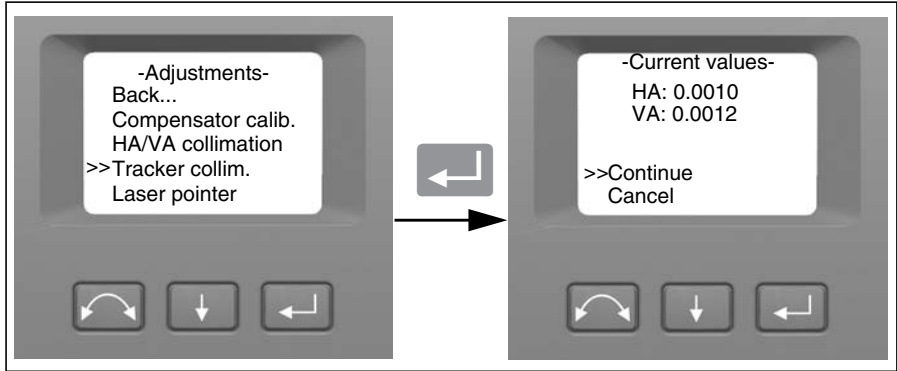

Note – The adjustment between the two optical axes, i.e. the Telescope and the Tracker, may differ. See *Aiming* on page 104

1. Press  to scroll to Tracker collim then press .

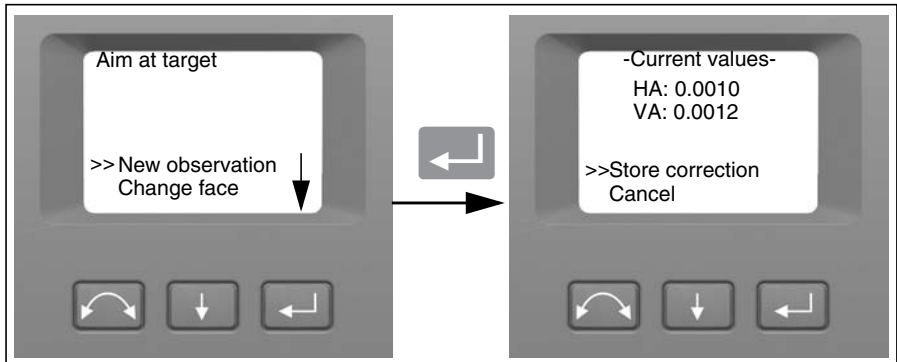

2. Accurately aim towards a prism.
3. Press  to scroll to New observation and then press .





4. The instrument will measure to the target in both faces automatically and then display the current values.
5. Press  to scroll to one of the following:
 - Store correction. Then press  to save the correction values.
 - Cancel. Then press  to return to the Adjustments menu
6. Once the instrument has stored the correction values, the Adjustments menu appears.

Laser Pointer

The laser pointer is a visible laser that is emitted from the telescope along the line of sight. The laser is used to visibly indicate the point being measured, and is especially useful when employing the DR reflectorless EDM for measurement. The laser pointer is clearly visible in areas of shadow, inside buildings and tunnels and also at night, however in bright sunshine it is generally not readily visible with the human eye.

The following controls allow the laser pointer to be switched On and Off.

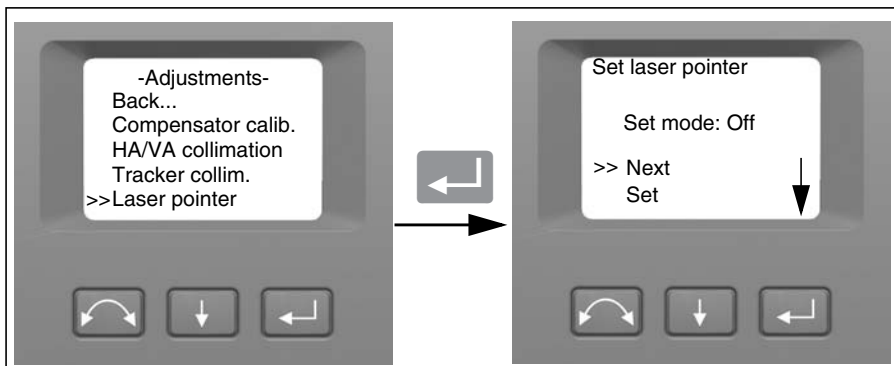

Note: The laser pointer is mechanically aligned to the telescope cross hairs. The laser may require periodic adjustment to keep it perfectly aligned for measurement. In order to adjust the laser pointer it has to be switched On, see page 4-72

1. Press  to scroll to Laser pointer then press .



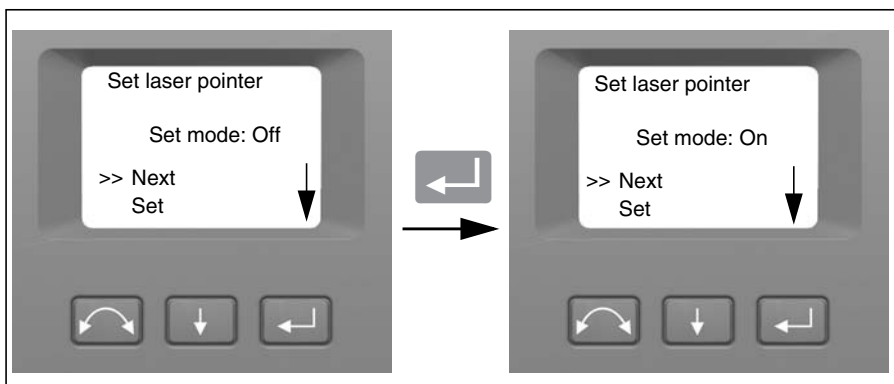

2. To change the laser pointer setting press  to select Next and then press  to select On or Off

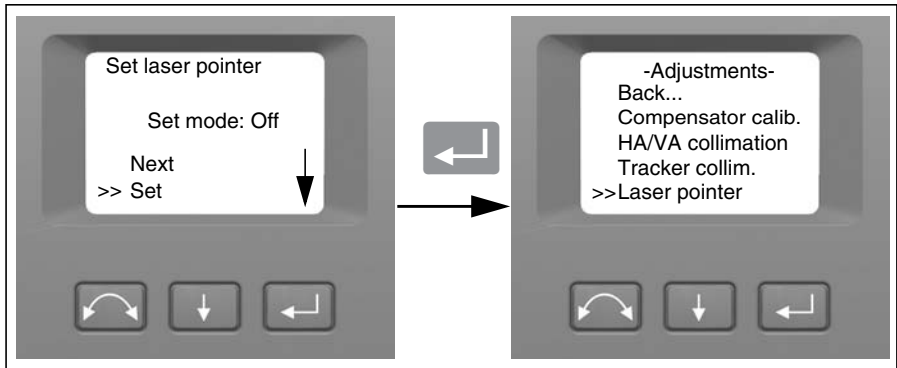

3. When you have found the setting of your choice press  to select **Set** and then press  to store this setting. You will then be returned to the **Adjustments** menu.





4. If you want to cancel press  to select **Cancel** and then press  to return to the **Adjustments** menu.

With the laser pointer on, you can adjust the beam, For more information, see *The Laser Pointer*, page 72.

Autofocus calibration

The Trimble SPSx30 Total Stations are equipped with an autofocus function. Before you can start using the autofocus, the function needs to be calibrated.

To start the calibration

1. Remove the CU from the instrument
2. Level the instrument. The instrument will automatically check if the compensator is within range before the calibration is started.
3. Press  to scroll to **Autofocus calib** and press 

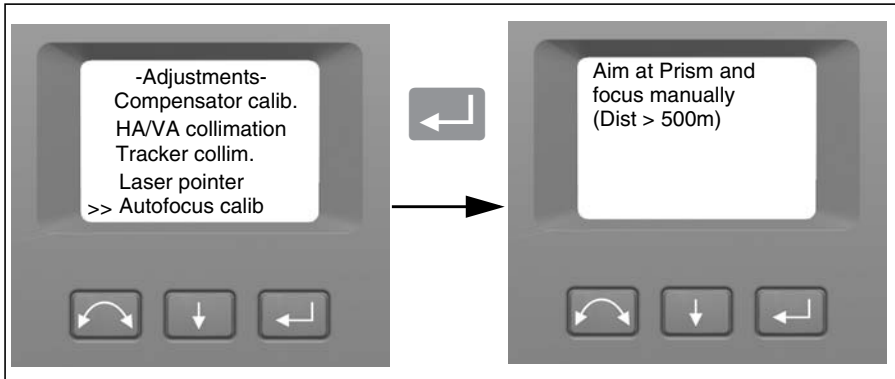

4. Aim and manually focus at a target at a distance of at least 500 meters Then press .

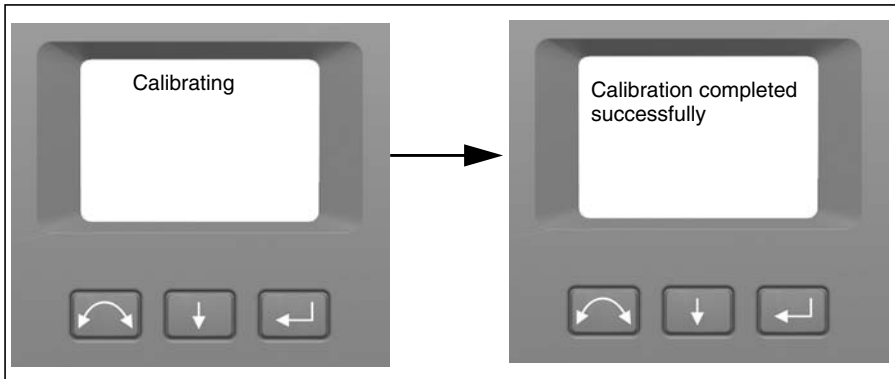

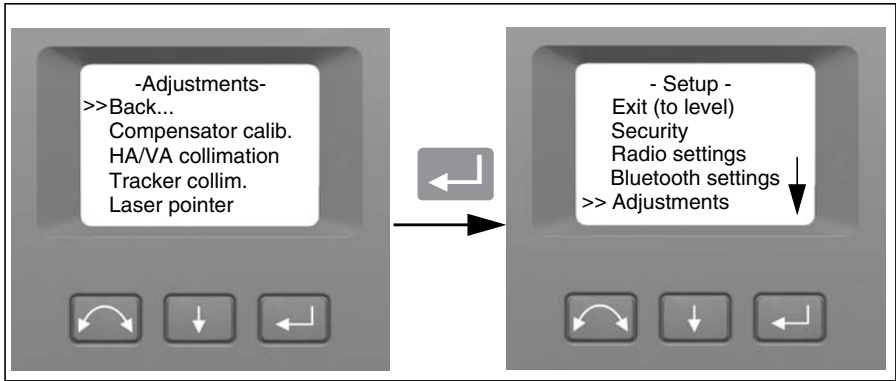

Back

1. To return to the Setup menu, press  to scroll to Back... and then press .



Firmware Version Information

1. Press  to scroll to Firmware version and then press . The instrument firmware version appears on the screen. The program will return automatically to the Setup menu.

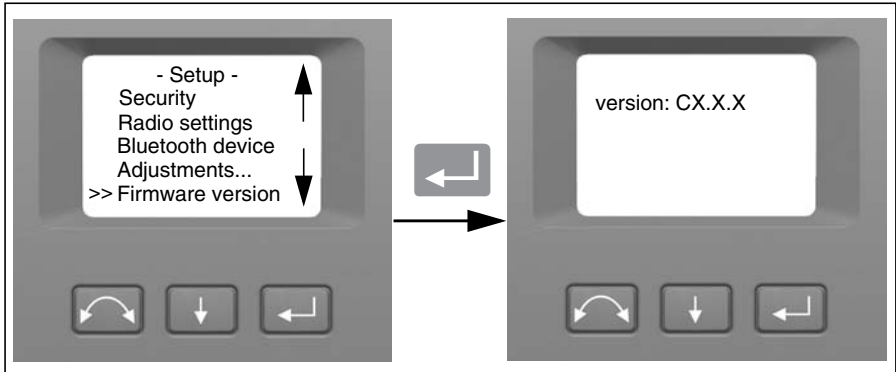

Servo Demo Mode

When firmware version is shown in the face 2 display it is possible to enter a servo demo mode. The servo demo function is to demonstrate the high speed capability of the servo system.



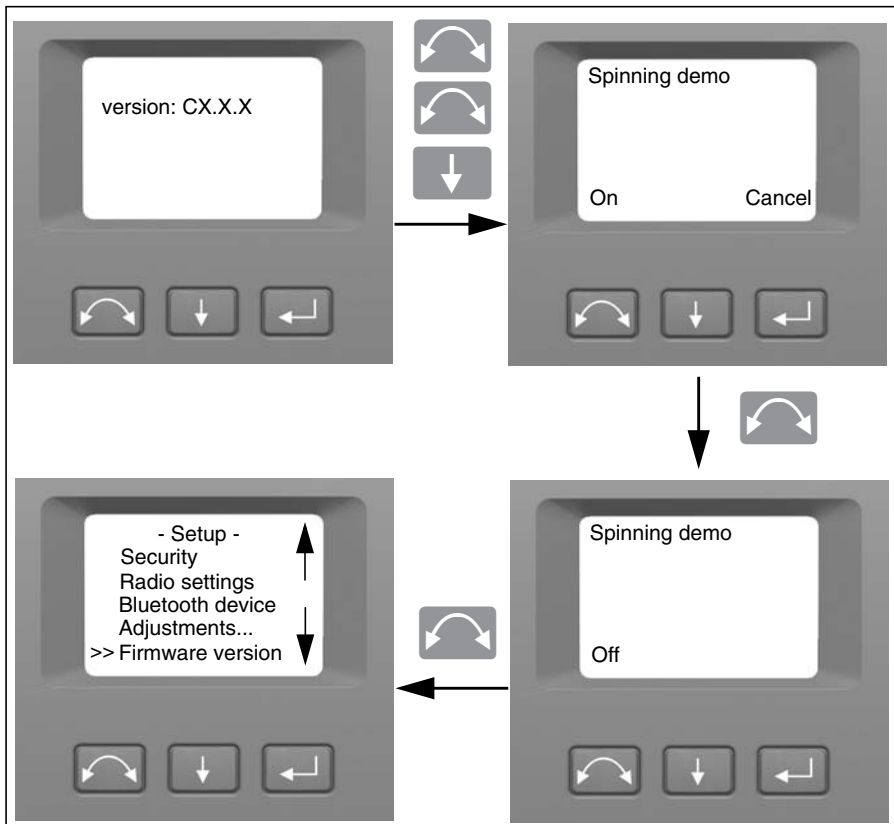

Caution – The instrument will start to rotate at high speed both horizontal and vertical. Make sure that the instrument has a stable set up.

1. Press to scroll to Firmware version and then press . The instrument firmware version appears on the screen.
2. While firmware version is displayed press .
3. When Spinning demo is displayed press to start the demo or to cancel and return to the Set up menu .
4. To end the Spinning demo press to stop rotation and return to set up menu.



Service Info



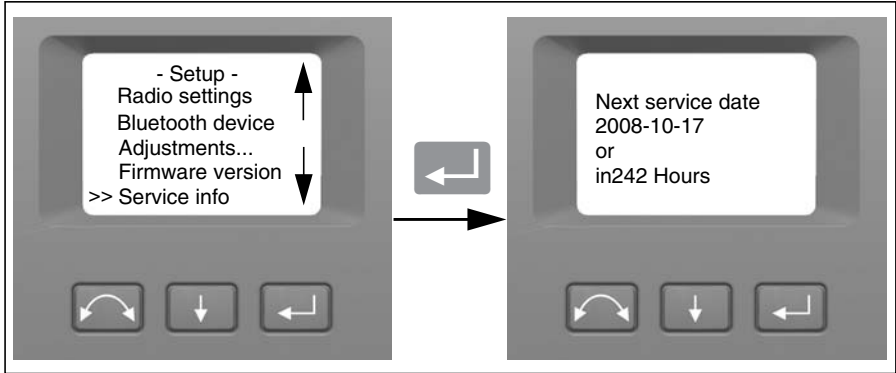

In the **Service info** menu it is possible to see the date for the next recommended service occasion or how many run time hours the instrument has left before service is recommended.

1. Press  to scroll to **Service info** and then press . The instrument service info appears on the screen. The program will return automatically to the **Setup** menu.



Select Language

In **Select language** it is possible to select the language for the Face 2 display.

1. Press  to scroll to **Select language** and then press .
2. Press  to scroll through the available languages.
3. Press  to set language.

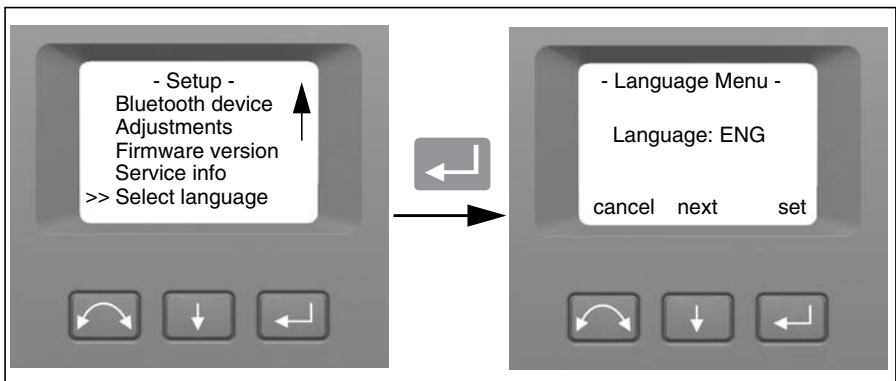

Exit Menu

1. To exit the Setup menu press  to scroll to Exit (to level) and then press . The electronic level appears.

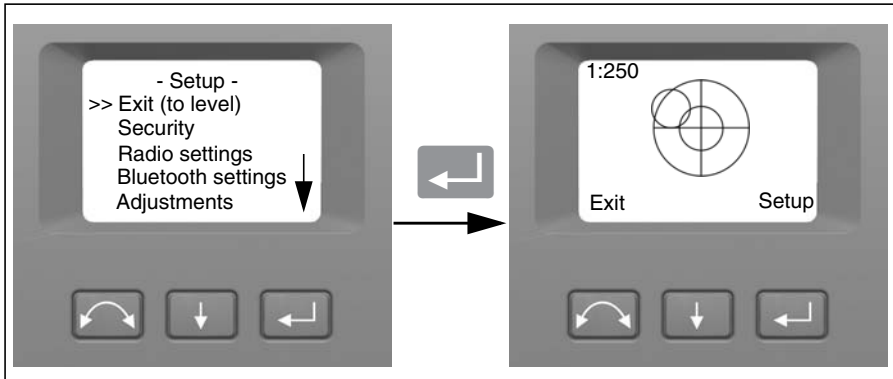

Note – If the instrument is left idle for more than 300 seconds (5 minutes) during any of the above routines, then the instrument goes to suspend mode.

The Laser Pointer

The Trimble SPSx30 DR Plus Total Station uses a red laser only as a laser pointer. The laser pointer is coaxial with the line of sight of the telescope. If the instrument is well adjusted, the red laser pointer coincides with the line of sight. External influences such as shock or large temperature fluctuations can displace the red laser pointer relative to the line of sight.

Aligning the Laser Pointer



Caution – Viewing the laser spot on the adjustment target through the telescope is safe. Do not try to make the adjustment using a prism, the reflected light from a prism can dazzle your eyes.



Caution – Do not use the laser pointer as an aid when searching for prisms, the reflected light can dazzle your eyes. The reflected light will not damage your eyes, but might be uncomfortable.

To avoid erroneous pointings using the laser pointer, use the supplied adjustment target to check the laser alignment regularly and before you attempt precise distance measurements:

1. Setup the adjustment target 25–50 meter away, facing the instrument.
2. Activate the laser pointer function to switch on the red laser beam.
3. Aim the instrument to the center of the target plate and then inspect the position of the red laser spot in relation to the telescope cross-hairs.
4. If the red laser spot lies outside the cross-hairs, adjust the direction of the beam until it matches the cross-hairs, see Figure 4.28.

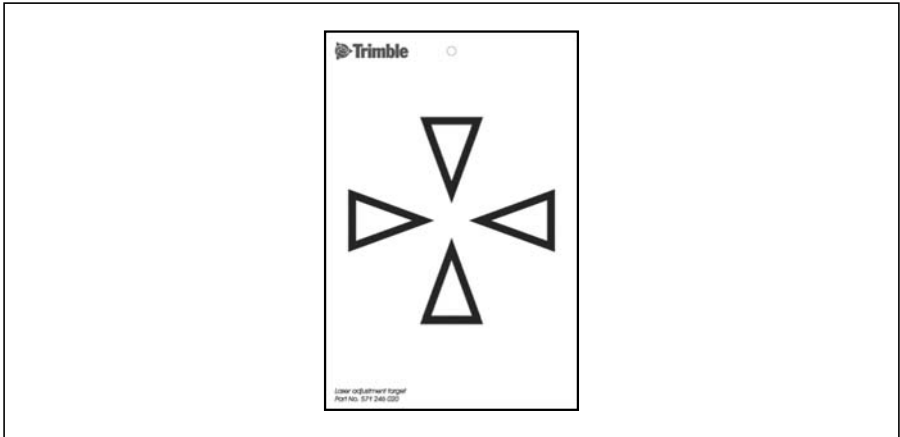

Figure 4.28 Adjustment target for DR Plus

Adjusting the Laser Beam

1. Pull out the two plugs from the adjustment ports on top of the telescope housing as shown in Figure 4.29

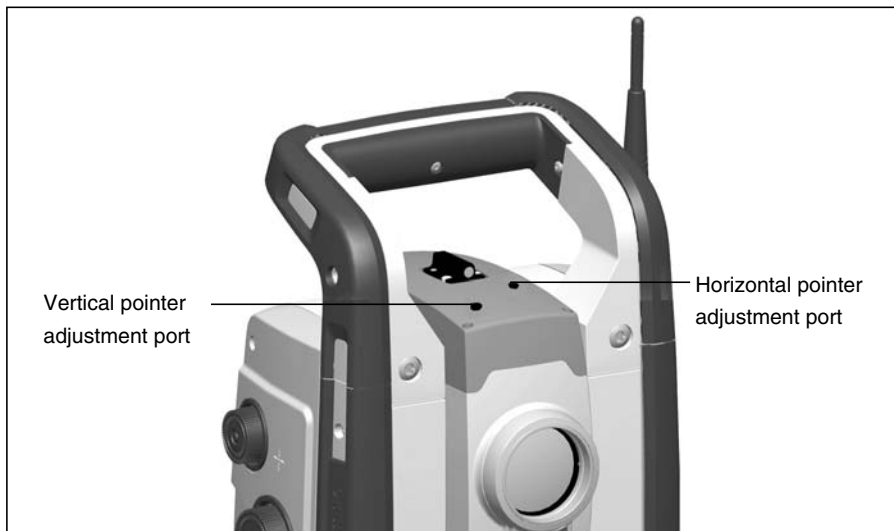

Figure 4.29 Laser pointer adjustment ports

4 Setup

2. To correct the vertical position of the laser spot, insert the allen key into the vertical adjustment port and turn it as shown in figure 4.30.

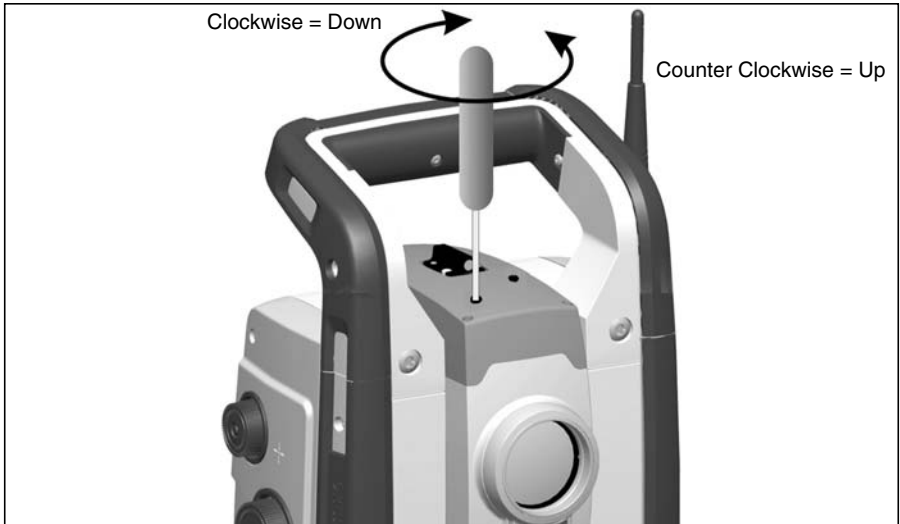

Figure 4.30 Vertical position adjustment

3. To correct the horizontal position of the laser spot, insert the allen key into the horizontal adjustment port and turn it as shown in Figure 4.31.

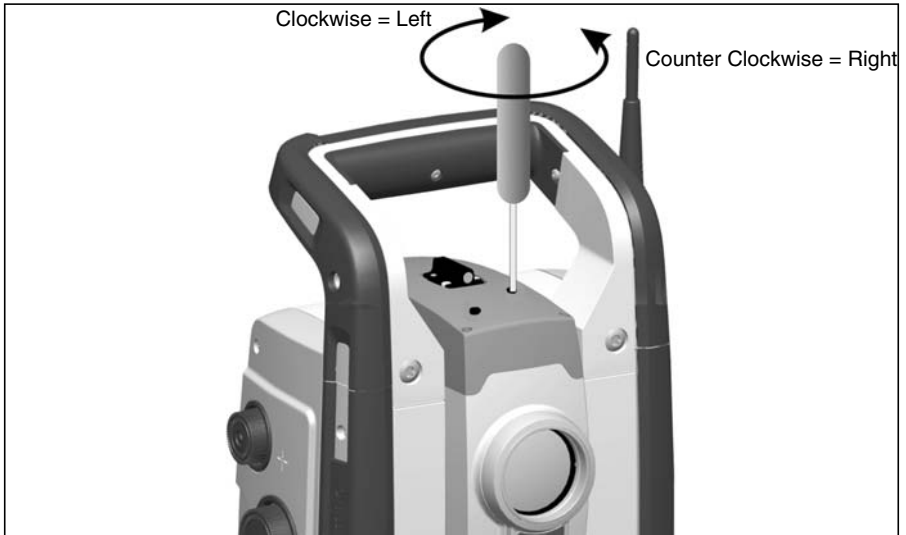

Figure 4.31 Horizontal position adjustment

4. Check the alignment of the laser spot and the cross-hairs. Throughout the adjustment procedure, keep the telescope pointing to the adjustment target. The adjusting screws are of a high tension because they are self locking. The screws tighten automatically after you adjust them.
5. Refit the plugs in the adjustment holes. Make sure that the plugs are correctly fitted for proper sealing against the cover.



Caution – To keep out moisture and dust, make sure that the plugs are correctly fitted in the adjustment ports.

Measuring the Instrument Height

There are two measurement marks on the side of the instrument. The top mark corresponds to the trunnion axis of the instrument. The bottom mark is 0.158 m (0.518 ft.) below the top mark. Measure the bottom mark to the top ridge of the mark as shown in Figure 4.32

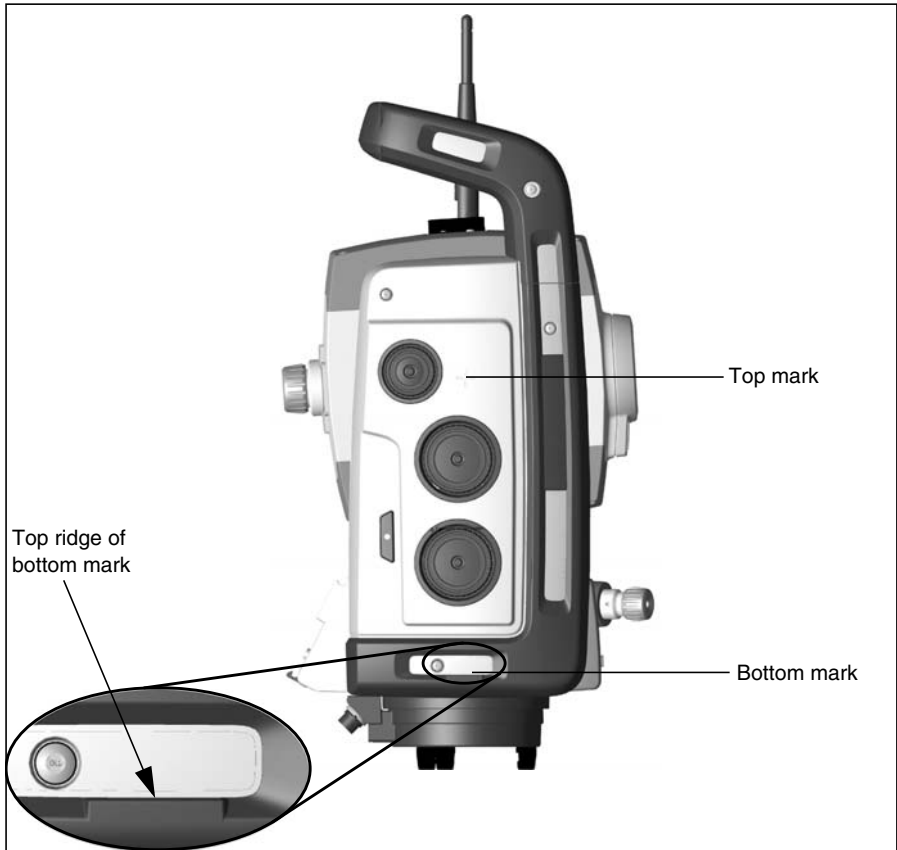

Figure 4.32 Instrument height marks

When there is a Trimble CU or TSC3 attached running Trimble SCS900, the software has additional functions that reduce the bottom mark measurement to the required vertical instrument height to the trunnion axis, see Figure 4.33 and the following paragraph.

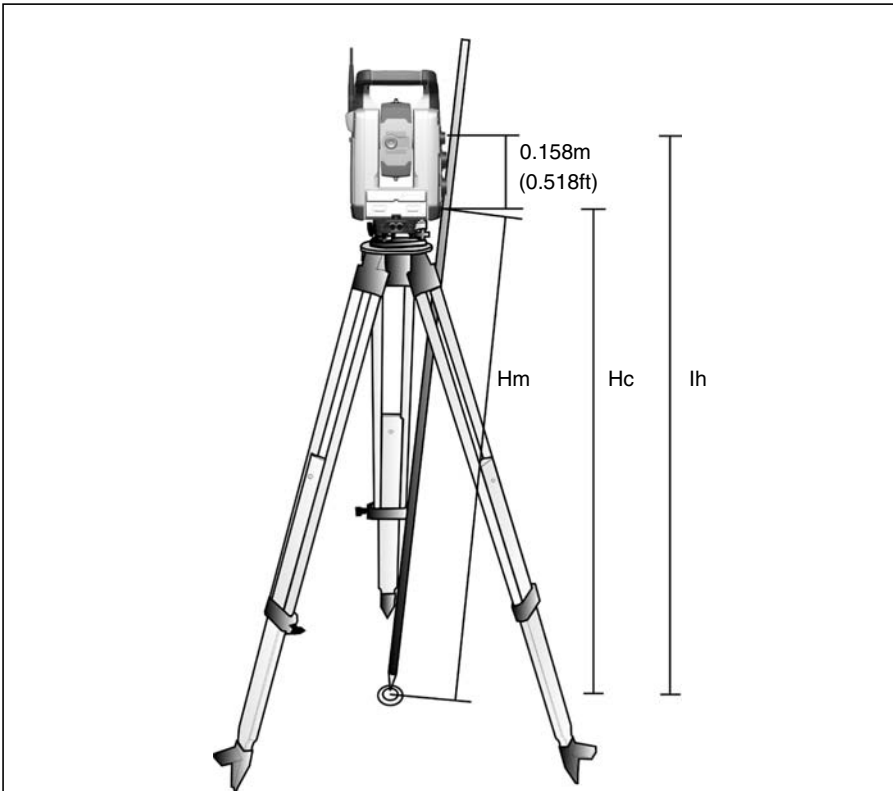

Figure 4.33 Instrument height measurement

The measured distance (H_m) is corrected for the slope of the measurement to obtain a vertical measurement to the bottom mark (H_c). The constant from the bottom mark to the top mark (0.158 m/0.518 ft.) is added to the H_c to obtain the vertical instrument height from the ground mark to the trunnion axis (I_h). For more information, refer to the SCS900 documentation.

Alternatively, to obtain an accurate measurement to the top mark (I_h), you can manually measure the slope distance from the ground to the bottom mark (H_m). To calculate the total instrument height (I_h), insert the measured slope distance (H_m) into the formula below:

$$I_h = 0,158 + \sqrt{H_m^2 - 0,091^2}$$

Adjusting the Optical Plummet

1. Set up the instrument and level it over a ground mark so that the tripod height is 1.5 m (± 0.1 m) (4.920 ft. (± 0.328 ft.)) as shown in Figure 4.34
2. Note the position of the inner circle of the optical plummet in relation to the ground mark.
3. Turn the instrument 200 grads (180 degrees).
4. Note the position of the inner circle of the optical plummet in relation to the ground mark. If the inner circle of the optical plummet reticule moves in relation to the ground mark, you must adjust the plummet reticule location.
5. Adjust out half of the error with the four adjustments screws on the optical plummet.
6. Turn the instrument 200 grads (180 degrees).
7. If there is no movement between the inner circle of the optical plummet reticle in relation to the ground mark, no further adjustment is needed.



Caution – When adjusting the optical plummet with the four adjustment screws it is important that the screws are correctly adjusted. When one screw is adjusted the opposite screw must be adjusted equally in the reverse direction, in order to keep the correct tension on the optics. Do not overtighten the screws, this might damage the optics.

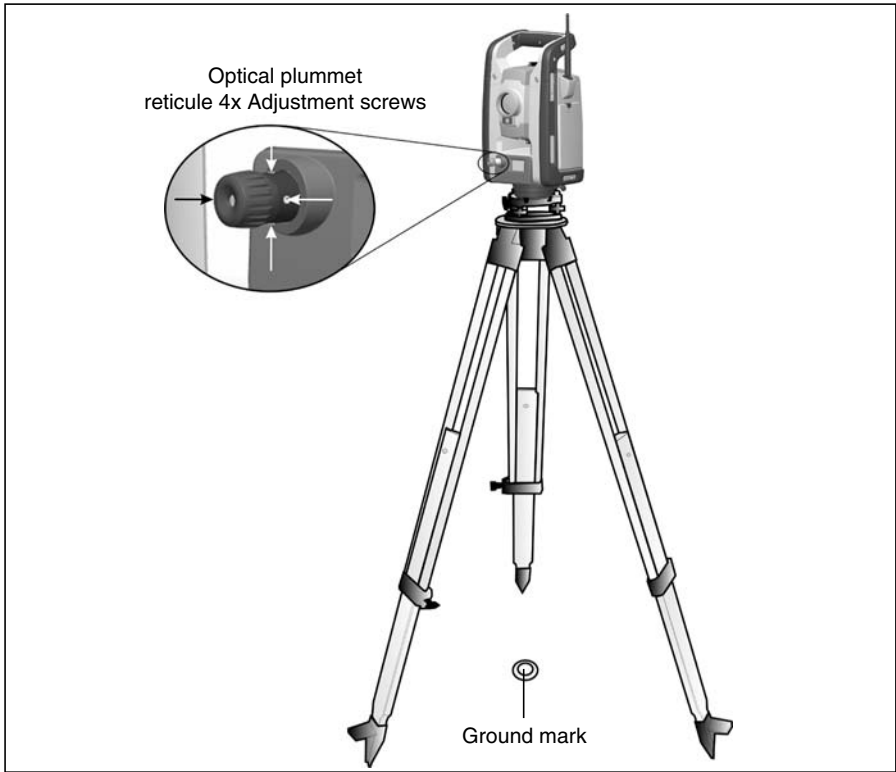

Figure 4.34 Optical plummet adjustment

Pre Measurement Check List

Before you begin measurement or stake out operations, check the following items:

- Lenses are clean
- Instrument is correctly leveled
- Correct radio channel is selected (robotic measurements only)
- Measure instrument height
- Allow sufficient time for the instrument to adjust to the ambient temperature, see page 36

Attaching the Trimble CU/Face Plate Cover

The Trimble SPSx30 Total Station is delivered with a cover for the panel holder. The cover for the panel holder is attached to the instrument in the same way as the Trimble CU.

Note – The panel attachment cover is not a necessity for operation or for waterproofing the instrument, it is designed to keep the contacts clean and free from dust and dirt over time only. For users using a TSC3 or Tablet type controller, the panel attachment cover should be used at all times to keep the contacts protected.

1. Hook the top of the Trimble CU over the top edge of the panel attachment as shown in Figure 4.35



Figure 4.35 Attaching the Trimble CU to the instrument

2. Push the bottom of the Trimble CU toward the panel attachment until it clicks into place as shown in Figure 4.36



Figure 4.36 Attaching the Trimble CU

Detaching the Trimble CU/Face Plate Cover

The Trimble SPSx30 Total Station is delivered with a cover for the panel holder. The cover for panel holder is detached from the instrument in the same way as the Trimble CU.



Caution – When the Trimble CU is removed from the instrument it is recommended to have the Trimble CU in suspend or off mode.

To remove the Trimble CU from the instrument when in on mode will not damage the equipment, but files that are being saved or written to when the Trimble CU is being removed might be damaged or lost.

1. Push the lock release button on the bottom of the Trimble CU as shown in Figure 4.37 (1)
2. Lift the bottom of the Trimble CU away from the instrument as shown in Figure 4.37 (2)



Figure 4.37 Detaching the Trimble CU

3. Unhook the top of the Trimble CU from the top edge of the panel attachment and remove the Trimble CU from the instrument as shown in Figure 4.38



Figure 4.38 Detaching the Trimble CU

Connecting a TSC3

The TSC3 can be used as a controller for the Trimble SPSx30 Total Station.

Servo and Autolock Mode

A TSC3 controller can be connected to the Trimble SPSx30 Total Station with a cable or by use of the Bluetooth® wireless technology.

Connecting With Cable

The TSC3 is connected from the Trimble SPSx30 Total Station com port to the serial port connector on the TSC3 using cable part number 53009012.

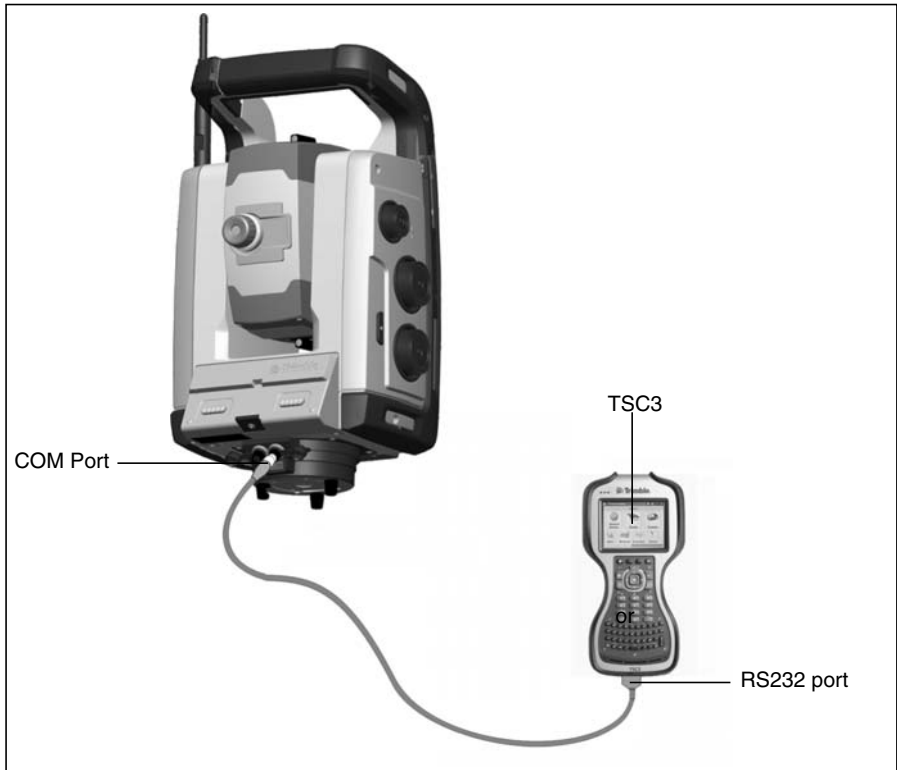

Figure 4.39 TSC3 connected to the TrimbleSPSx30 Total Station with cable for servo and Autolock measurements.

Connecting With Bluetooth® Wireless Technology



Caution – Before starting the Bluetooth device, make sure that the regulations of the country that you are working in allows the use of Bluetooth wireless technology.

The TSC3 has built in Bluetooth wireless technology.



Figure 4.40 TSC3 connected to the Trimble SPSx30 Total Station with Bluetooth wireless technology for servo and Autolock measurements.

Robotic Mode

The TSC3 is connected directly to the instrument via the built in radio.



Figure 4.41 TSC3 connected to the SPSx30 Total Station using the inbuilt radio for robotic measurements.

Lifting the Instrument

To lift the instrument, hold it as shown in Figure 4.42.

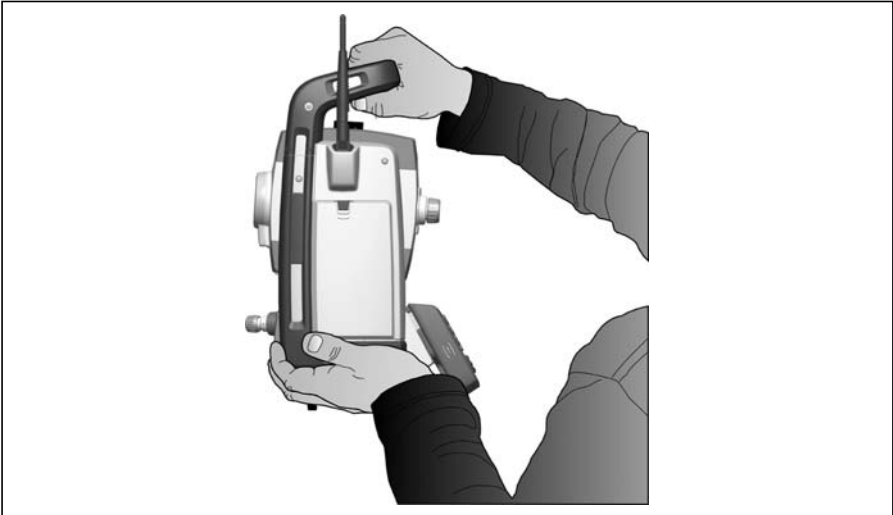

Figure 4.42 Correct way to lift the instrument

Do not hold the Trimble CU as you lift the instrument or you may accidentally push the lock release button, causing the Trimble CU to fall off the instrument, Figure 4.43

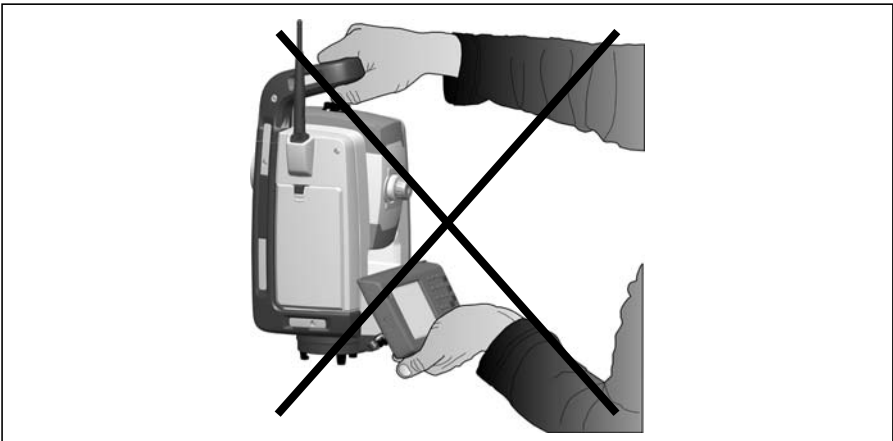

Figure 4.43 Wrong way to lift the instrument

Instrument Operation Methods

In this chapter:

- Introduction
- Conventional Measurement with Servo
- Autolock Measurement
- Robotic Measurement
- Machine Control & Machine Guidance

Introduction

This chapter describes the following instrument operational methods for the Trimble SPSx30 Total Station:

- Conventional measurement with servo
- Autolock measurement
- Robotic measurement
- Machine control & machine guidance

Conventional Measurement with Servo

The Trimble SPS Total Station is equipped with the servo system, which provides the following advantages for conventional measurement:

- When combined with the SCS900 Site Controller software:
 - When setting/staking out, the instrument calculates and automatically aims towards the calculated position of the selected point.
 - The instrument will automatically point towards a selected reference target to check for instrument movement during measurements.
- SurePoint™ technology corrects the instrument pointing for mislevelment and collimation / trunnion axis tilt errors in real time.
- SurePoint™ technology restores the instruments pointing after accidental bumps, vibration or wind.
- The servo drives are continuous and endless allowing for rapid repeat manual pointing of the instrument with no end stops.

Note – To obtain the correct point location with the instrument, you must aim correctly to the target.

Autolock Measurement

Combining the servo capability with the Autolock tracker provides the ability to carry out Autolock measurements. Autolock enables the instrument to automatically lock on to a prism, and then follow it precisely as it moves. This means that the instrument is taking care of the pointing, and that position can be continuously updated as the target moves around the jobsite. Autolock is especially useful for carrying out rapid site topo measurements and during stakeout using a conventional two person crew. It is also exceptionally useful for working in poor visibility and darkness conditions, and for automatically checking or measuring to multiple reference targets.

Robotic Measurement

Combining the servo, tracker and radio capability enables the instrument to carry out measurements robotically. This enables a single operator to control the instrument and carry out measurements or set/stakeout from the rod at the point.

Reflectorless Measurement

The SPSx30 instruments combine long range, pulsed laser reflectorless DR measurement capability with the ability to scan using servos and measure at a rate of 3Hz. This provides the ability to measure from any surface at up to 2000m (6560ft) range without a prism (depending on accuracy required) or to automatically scan profile lines on rock faces or scan a surface using a grid pattern of points (using the SCS900 software).

Machine Control & Machine Guidance

The SPSx30 Universal Total Stations have been designed to operate as a universal total station. The instruments have a machine control mode that optimizes the angle and distance measurement system through a synchronization process that also reduces latency of the data. In addition the instruments when in machine control mode will output data at a higher rate than conventional total stations (20Hz). The instrument radio system is designed to reduce jitter significantly, the instrument tracking and search functions are optimized for dynamic tracking applications, and the instrument also features trajectory prediction helping reacquire lock if the prism is obscured.

When operated in Site Positioning mode and SCS900 Tablet Edition is used in Vehicle mode the instrument will also utilize the high update rates and synchronized data, however the radio master is at the instrument allowing for a one to one operation with the robotic rod controller. When operated in Machine Control mode, the radio master shifts to the machine. In this mode the radio system is also optimized to eliminate jitter, which provides enhanced positioning control for the machine system hydraulics.

Please refer to the application software user guide to determine the proper startup procedure for the machine control or machine guidance application you use.

When used for any machine control application, the instrument should be setup first with the SCS900 software, a station establishment carried out and then perform the shut down process and place the instrument in Machine Control mode. This process involves placing the station establishment information in the instrument memory, so that it can be transferred to the calling machine control application.

The instrument capability to track moving vehicles and machines is referred to as Advanced Tracking Sensor (ATS).

Advance Tracking Sensor (ATS) Capability

ATS capability delivers the following performance benefits for dynamic positioning applications

- Low, fixed and well defined latency of data output from the instrument and over the radio
- Synchronized angle and distance measurements
- 20Hz data update rates
- 16 Channel Target ID - 1-8 are used for Site Positioning mode and 9-16 for Machine Control mode.
- Dedicated radio channels for site positioning (channels 1-30) and machine control (channels 31-60)
- Optimized search routines designed for tracking a machine with trajectory prediction.
- Radio scanning capability, instrument can be programmed to sequentially scan a series of radio channel and network ID combinations, allowing it to serve a number of machines, all on different channels at a single location on demand.

Instrument Technology

In this chapter:

- 3D Positioning Technology
- Distance Measuring Technology
- Trajectory Server
- Tracker Technology
- Tracklight
- Servo Technology
- Power Management
- Power Supply
- External Communication

3D Positioning Technology

The Trimble SPSx30 Total station utilizes a combination of precise angle measurement technology in the horizontal and vertical planes and precise distance measurement capability to establish the 3D position of a target location. The distance measurement system can either utilize a prism located at the point to be measured, or its DR Plus reflectorless measurement capability to measure from any surface in the line of sight of the telescope.

The principles of angle measurement are based on reading an integrated signal over two opposite areas of the angle sensor and producing a mean angular value. This eliminates inaccuracies caused by conventional circle eccentricity and graduation.

In addition, the angle measurement system compensates for the following automatic corrections:

- Instrument mislevelment (deviation of the plumb axis).
- Horizontal and vertical collimation error.
- Trunnion axis tilt. See page 96

Correction for Mislevelment

The Trimble SPSx30 Total Station automatically corrects for mislevelments up to $\pm 6'$. The instrument warns the operator immediately of any mislevelments in excess of $\pm 6'$ (± 0.11 grads).

The Trimble SPSx30 Total Station also utilizes Surepoint™ to automatically correct the pointing of the telescope for all mislevelment and trunnion axis errors in real time during operation.

The Trimble SCS900 software operating on a Trimble controller computes and applies the corrections for all of these errors in all 3D positions generated by the instrument.

Correction for Collimation Errors

The horizontal collimation error is the deviation of the sighting axis from its required position at right angles to trunnion axis.

The vertical collimation error is the difference between the vertical circle zero and the plumb axis of the instrument.

Traditionally, collimation errors were eliminated by observing angles in both instrument faces. In the Trimble SPSx30 Total Station, a pre-measurement collimation test is performed to determine the collimation errors. Angular measurements are observed in both instrument faces, the collimation errors are calculated, and the respective correction values are stored in the instrument. The collimation correction values are then applied to all subsequent angle measurements that are used to generate 3D point positions with the instrument.

Measurements made in a single face are corrected for collimation errors, which eliminates the need to measure in both instrument faces.

Carry out a collimation test in the following situations:

- Whenever the instrument may have been roughly handled during transport.
- When the ambient temperature differs by more than 10°C (18°F) from the previous collimation test.
- Immediately prior to high precision angle measurements in one face.

Trimble SPSx30 Total Station With Tracker Technology

A Trimble SPSx30 Total Station with tracker technology can automatically lock and track a prism target. Pointing errors caused by slight misalignment of the instrument's tracker have a similar effect to the HA and VA Collimation errors detailed above.

To correct for the tracker collimation errors, carry out a tracker collimation test. The tracker collimation test automatically observes angular measurements to a target in both faces, the tracker collimation errors are calculated and the respective correction values are stored in the instrument. The tracker collimation correction values are then applied to all subsequent position measurements observed when Tracker is enabled. Angles observed in a single face are corrected for collimation errors, which removes the need to measure in both instrument faces.

Carry out a tracker collimation test in the following situations:

- Whenever the instrument may have been roughly handled during transport.
- When the ambient temperature differs by more than 10°C (18°F) from the previous collimation test.
- Immediately prior to high precision angle measurements using Tracker in a single face.

Correction for Trunnion Axis Tilt

The trunnion axis tilt error is the deviation of the trunnion axis of the telescope from its required position at right angles to the plumb axis of the instrument. See figure 6.44

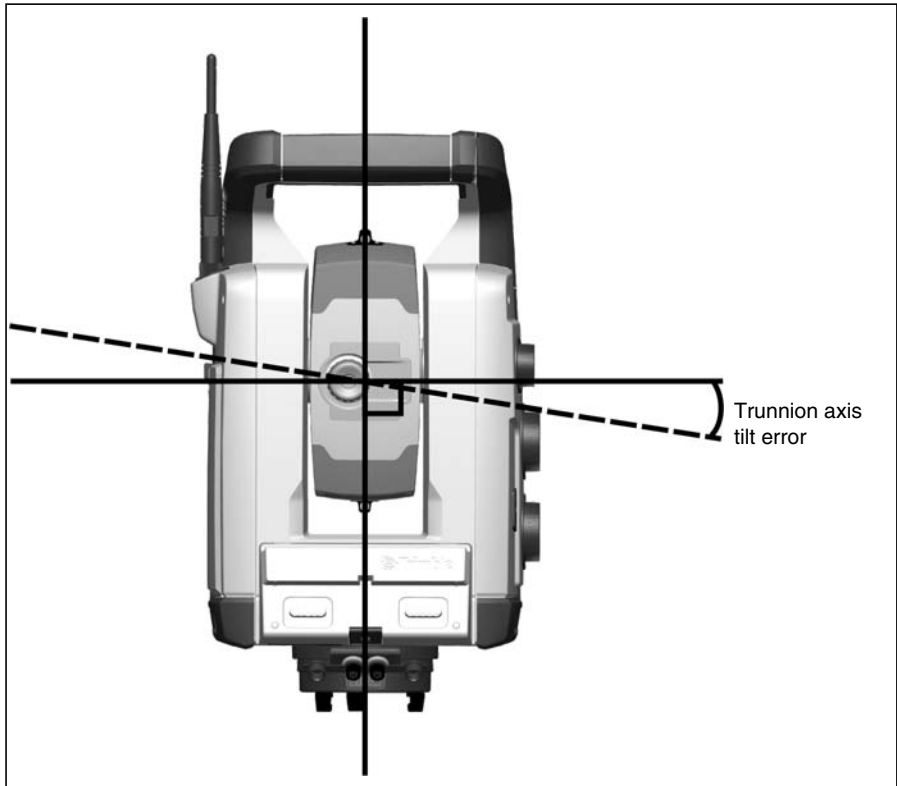

Figure 6.44 Trunnion axis tilt error

In the Trimble SPSx30 Total Station instrument, perform a pre-measurement trunnion axis tilt test to determine the trunnion axis tilt error. Angular measurements are observed in both instrument faces, the trunnion axis tilt error is calculated, and the respective correction value is stored in the instrument. The trunnion axis tilt correction value is then applied to all measured positions via a correction to the horizontal angle value and an automatic repointing of the telescope using Surepoint™ technology.

Carry out a trunnion axis tilt test in the following situations:

- Whenever the instrument may have been roughly handled during transport.
- When the ambient temperature differs by more than 10°C (18°F) from the previous collimation test.

- Immediately prior to high precision angle measurements in one face, especially where the vertical angles significantly deviate from the horizontal plane.

Averaging Measurements to Reduce Sighting Errors

The Trimble SPSx30 Total Station instrument automatically reduces sighting errors caused by the misalignment of the instrument to the target or by pole movement during measurement. The following techniques can be used:

- Use Autolock. When Autolock is enabled, the instrument automatically locks onto and tracks the target. Manual sighting errors are reduced.
- Automatically average angles during distance measurement. When measuring in Standard mode, the instrument takes approximately 1.2 seconds to measure the distance. Angles returned to the instrument at 1000 Hz, are averaged over the 1.2 second period to obtain an averaged angle measurement. The resultant angle measurement is an average of over 1200 observations.

Distance Measuring Technology

Trimble SPSx30 Total Station instruments are equipped with a combined distance unit. This means that the instrument can measure to a prism or to normal surfaces (direct reflex (DR) mode). The instrument is available with a DR Plus distance unit. The following sections describe the two systems.

DR Plus

The DR Plus is a pulsed laser distance unit that determines distances by precisely measuring the flight time of the transmitted light pulse. The distance unit generates many short laser pulses, which are transmitted through the telescope to the target. The pulses reflect off the target surface and return to the instrument where the unit determines the time difference between the transmitted pulses and the received pulses. The unit uses the time difference to calculate the distance to the target.

The DR Plus distance unit includes additional functions that allow you to control the accuracy and precision of a DR measurement through the field application software.

Trimble SCS900 field application software includes:

- **Standard Deviation.** This allows you to configure the required precision of the DR measurement before the distance will be accepted. The distance measurement process will be carried out by the instrument until the preset standard deviation value has been achieved. The default standard deviation value is 0.003m. Setting this value to a higher number gives shorter measurement time but is less accurate, especially when measuring to surfaces at greater distances or at oblique angles to the line of sight.
- **Weak Signal.** This allows you to accept a DR measurement that is below the normal instrument specification. This is useful when measuring to poor reflective surfaces, or when trying to achieve the maximum range of the instrument.
- **Min.-Max Range.** This allows you to specify the DR measurement interval. For example, when you measure to a small object at 50 m with a background object at 200 m, set the min.-max range from 2 m to 100 m. The distance meter is then tuned to provide a distance within the specified range and to ignore any signal from outside the defined range. By default, the min.-max range is 1.5–600 m.

Beam Divergence

All distance meter measurement beams diverge as the range from the instrument increases. The divergence of the distance meter beam relates to an increase in the size of the area being sampled, not to a degradation of the measurement precision. See figure 6.45

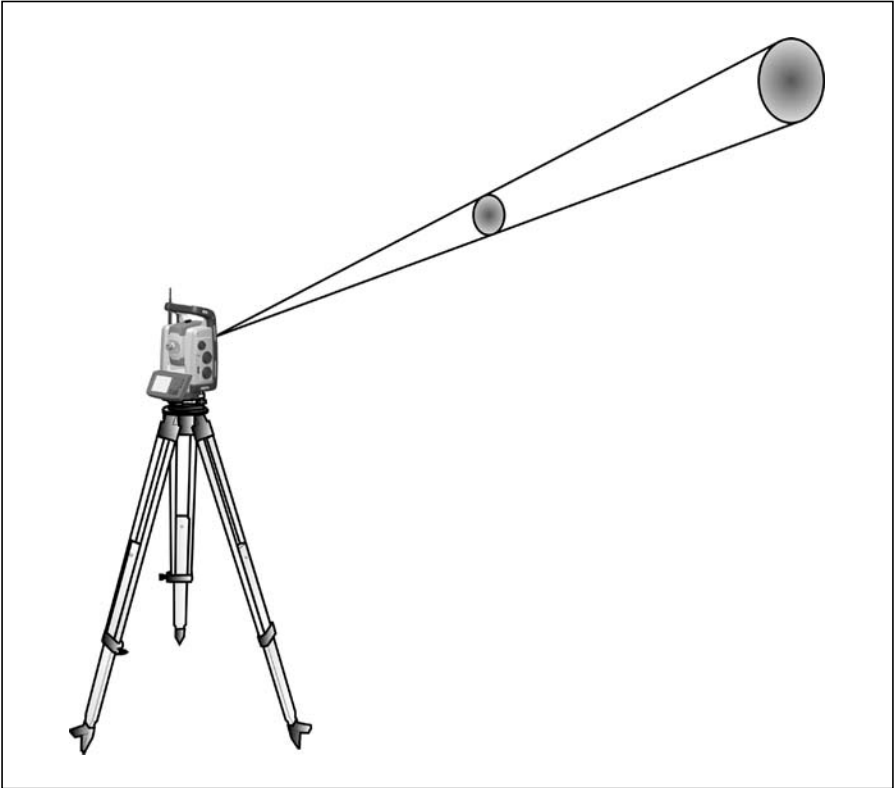

Figure 6.45 Beam divergence

A larger measuring area at longer range is generally better because it enables smaller objects, such as power lines and antennas, to be detected and accurately measured. With a smaller measuring area, these small objects can be easily missed. A smaller measuring area has advantages when measuring tight corners and vertices at close range. When observing measurements to a tight corner, the distance meter beam divergence introduces a range error caused by the size of the sampling area. See figure 6.46

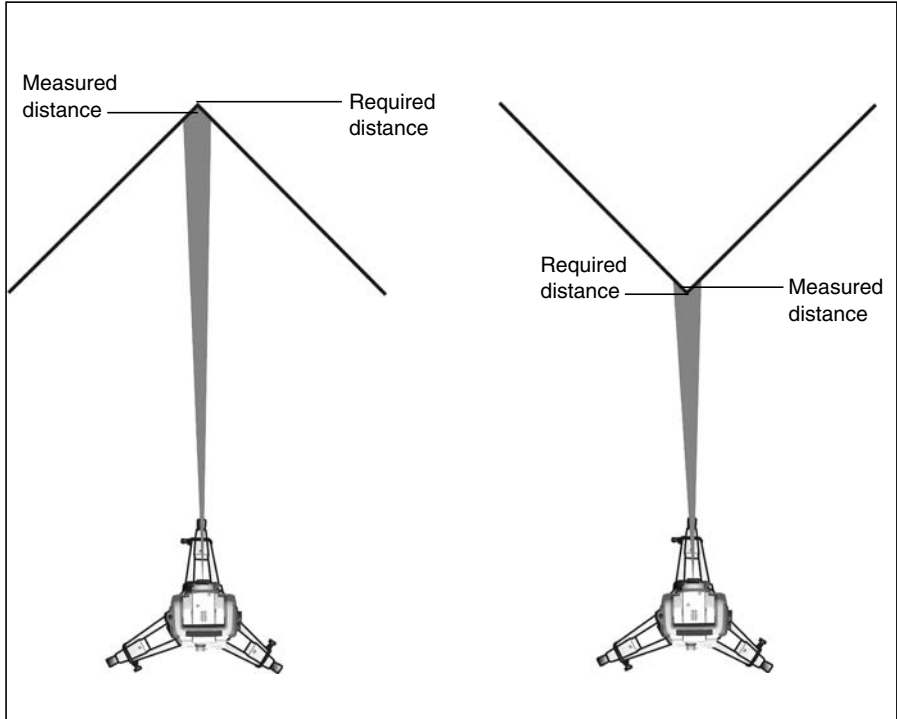

Figure 6.46 Measuring to an inner and an outer corner

Be aware of the measurement beam footprint size when measuring using reflectorless techniques.

Trajectory Server

The Trimble SPSx30 Total Station are equipped with Trimble's patented Trajectory Server. The Trajectory Server System estimates the trajectory of the target if the signal is interrupted by passing traffic or stationary object that causes temporary loss of signal during operation. As long as the machine is continuing along the same trajectory at a constant speed the Trimble SPSx30 Total Station will regain lock to the target as soon as the obstruction is removed (provided that happens within the time that the trajectory model is valid). The Trajectory Model timeout depends on the speed of the target, the measured distance from the instrument and the trajectory of the target in relation to the instrument.

Tracker Technology

The Trimble SPSx30 Total Station is equipped with Tracker technology.

Tracker technology controls the instrument servos and aims the instrument correctly towards the target. See figure 6.47



Tip – To assure maximum performance from the Tracker technology keep the lens clean and dry.

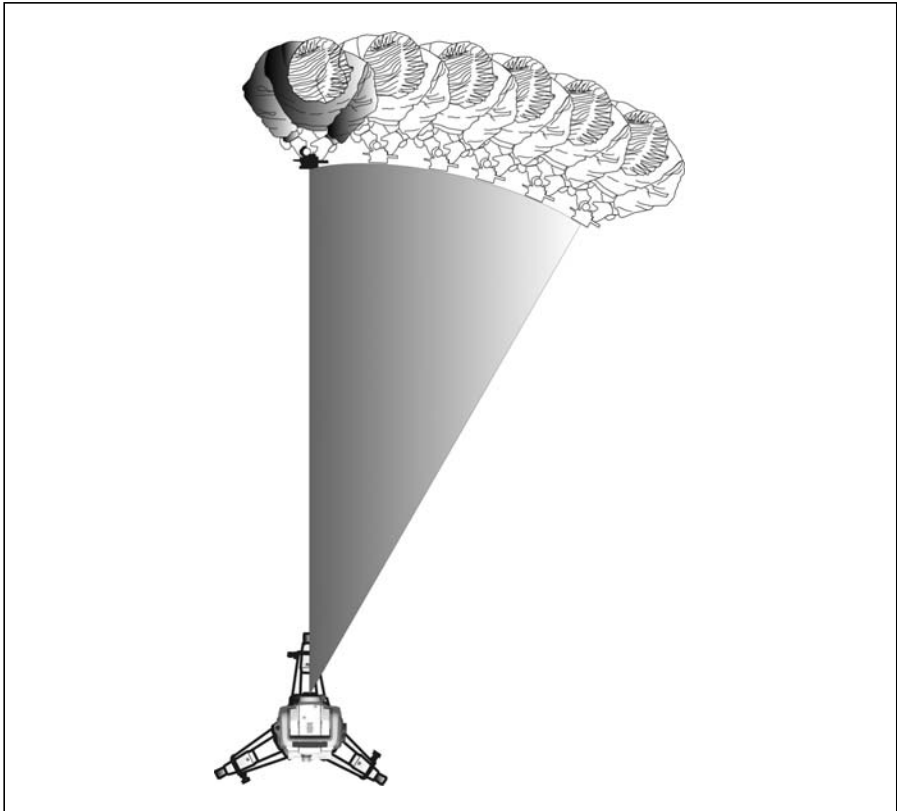

Figure 6.47 The Trimble SPSx30 Total Station Tracker function.

The Trimble SPSx30 Total Station can lock onto and track a target in three different modes depending on the type of target.

Passive mode:

In passive mode the instrument can lock onto and track a prism.

With Target ID

When Target ID is added to the 360 degree prism, SCS900 allows the Target ID to be used in one of three ways

1. Searching - The instrument only uses and checks the Target ID when looking for the prism, after which it returns to passive mode of operation, tracking the prism only.
2. Searching and Measuring - The instrument checks the Target ID when searching for the prism, and during measurement. If the appropriate Target ID is not seen, the SCS900 software will warn the user "Target Not Found" during measurement and on trying to record data.
3. Only tracking Horizontal - In this mode the instrument will use the Target ID as an Active target for tracking in the horizontal only, the vertical tracking is still carried out passively to the prism itself. For full active tracking the user should use the MT900 target on machines and vehicle mounted operations or the MT1000 MultiTrack target on a pole.

Active mode:

When the MT900 or MT1000 target is selected, the instrument will operate in Active Mode. In the Active mode the instrument tracks and checks the target ID only. Measurement only is taken from the prism.

Target type	Prism constant	Passive mode	Target ID mode	Active mode
Super prism	0 mm	X		
360 prism	2 mm	X		
360 prism + Target ID	2 mm	X	X	
MT900 target		X		X
MT1000 MultiTrack target	10mm	X		X

Selection of the appropriate mode can be made via the SCS900 software interface while selecting the 360 target with Target ID prism type.

Note – Make sure to select the correct target in the field software to ensure correct lock and tracking of the target.



Caution – For precision measurements, when using the 360 degree prism, it is important to turn the prism, so that one of the prisms is pointed at the instrument. There is a mark on the top of the prism housing to assist in aligning a prism to the line of sight for the instrument.

Aiming

The adjustment between the two optical axes, the telescope and the tracker, may differ. The difference will make it seem like the instrument does not point towards the center of the prism, when using tracker, figure 6.48. This is not a problem since the two axis have their own separate collimation data. It is however important to make collimation test for both axes.

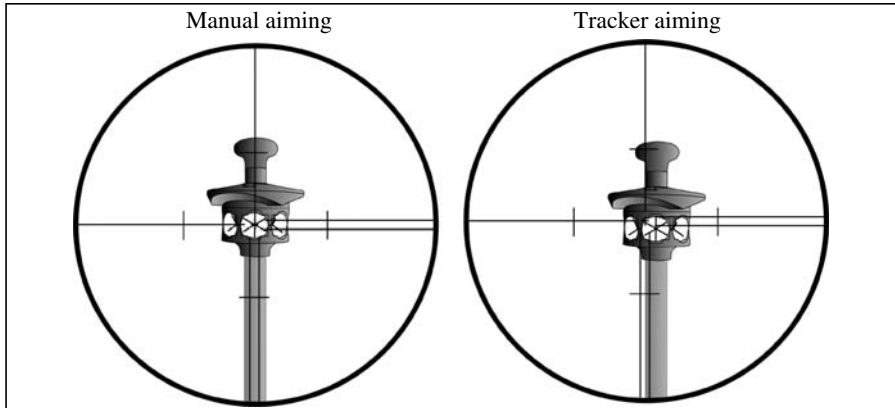

Figure 6.48 Difference between aiming manually and tracker aiming

How to Check Aiming

You can check how well the instrument is calibrated by measuring toward the prism with and without tracker and compare the measured angles:

1. Aim manually at a prism and read out the horizontal and vertical angles.
2. Turn on tracker and let the instrument lock on to the same prism automatically, read out the horizontal and vertical angles.
3. Compare the angles between manual and tracker aiming.

If the difference between the read out angles is significant, you should carry out both a horizontal and vertical angle collimation adjustment, and a tracker collimation adjustment.

After a full tracker collimation, the pointing of the instrument can still be different between manual and tracker assisted pointing. The angles to the target in both cases will however be the same - the collimation errors stored for the tracker will effectively make the instruments tracker pointing match the pointing when done with the human eye.

Tracklight

Tracklight[®] unit is a visible guide light that enables the rod holder to position themselves into the instrument's current line of sight. The Tracklight can be used during stakeout in all operational modes, and is also of great benefit when operating in robotic mode as a means of checking that the instrument is tracking, or when trying to reacquire lock by walking into the sight line of the tracker, or using the remote joystick control in robotic mode. Tracklight consists of a flashing two-colored light, with each color lying in its own lateral projection sector. If the rod holder is to the left of the measuring beam, they will see a red flashing light; if they are to the right, they will see a green flashing light. See figure 6.49

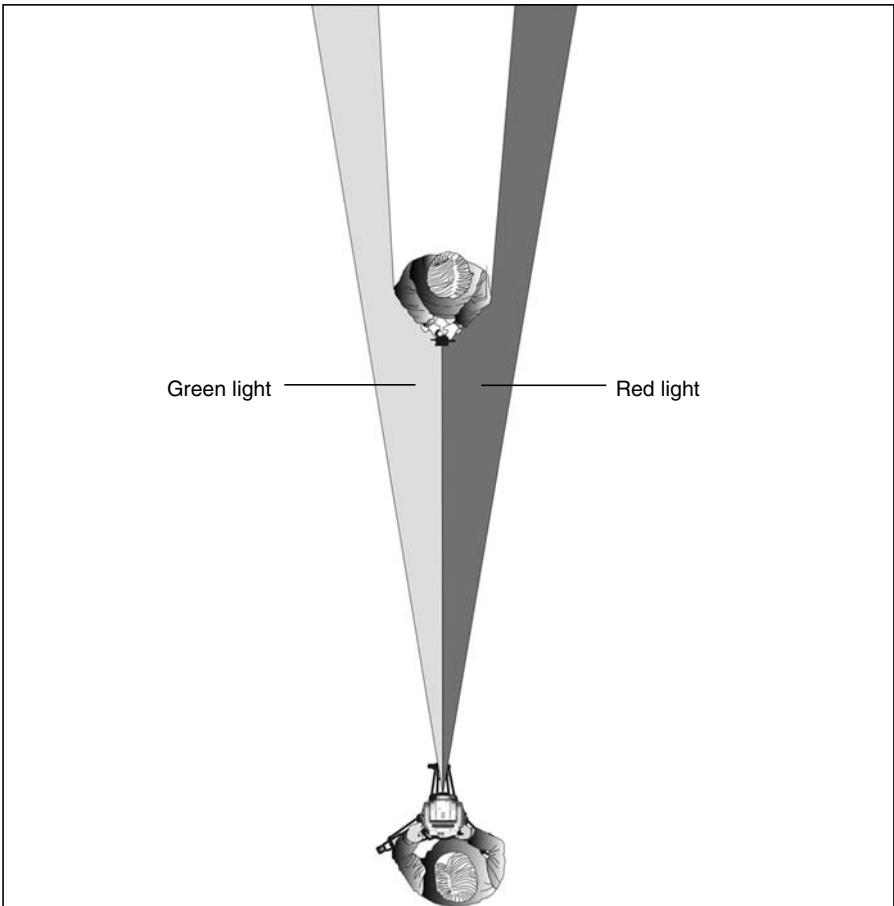

Figure 6.49 Tracklight



Tip – You can use the Tracklight for clearing sight lines and as an aid to find prisms in the dark or unfavorable sighting conditions.



Caution – Do not use the laser pointer as an aid when searching for prisms, the reflected light can dazzle your eyes. The reflected light will not damage your eyes, but might be uncomfortable.

Servo Technology

The Trimble SPSx30 Total Station is equipped with servo controlled motors to position the instrument and focus the telescope.

Due to the high speed position servo and the SurePoint™ technology used in the Trimble SPSx30 Total Station it is important to use a high quality tripod and tribrach. It is also important to set up the tripod in a position for best stability, see figure Figure 6.50. If the setup, tripod and/or tribrach is/are unstable the instrument servos might oscillate slightly in an effort to compensate for that instability. An unstable setup could negatively influence the resulting measurement precision. See Setup on page 36

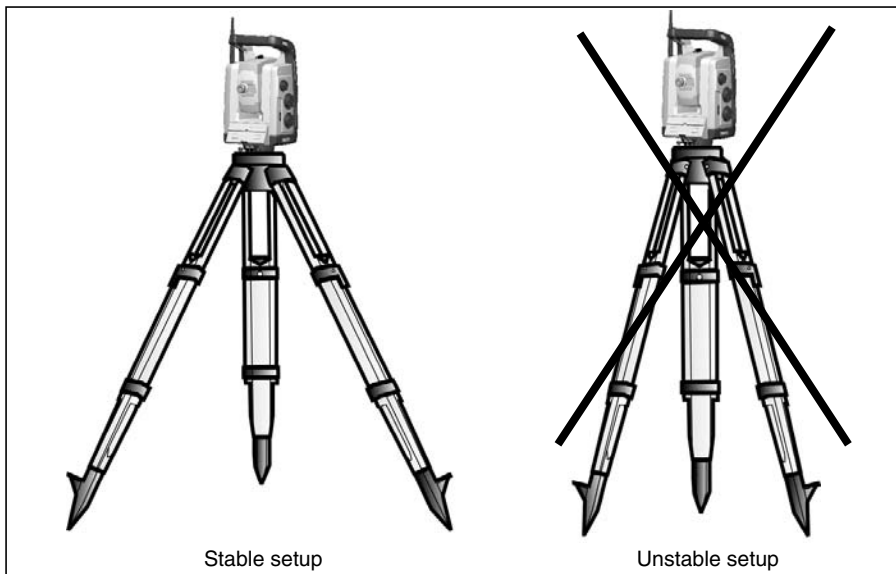

Figure 6.50 Tripod setup

Position Servo

Trimble MagDrive™ servo technology is an electromagnetic direct drive servo system which gives high turning speeds and accuracy. The frictionless motion removes servo noise and reduces instrument wear. The system provides endless horizontal and vertical motion, including endless fine adjustment. The instrument uses servo when performing a number of different operations such as turning the horizontal and vertical motion knobs, for automatic test and calibration, or when using tracker technology for robotic surveying. See figure 6.51

Note – Due to the high speed servo it is important to use a high quality tripod and tribrach.

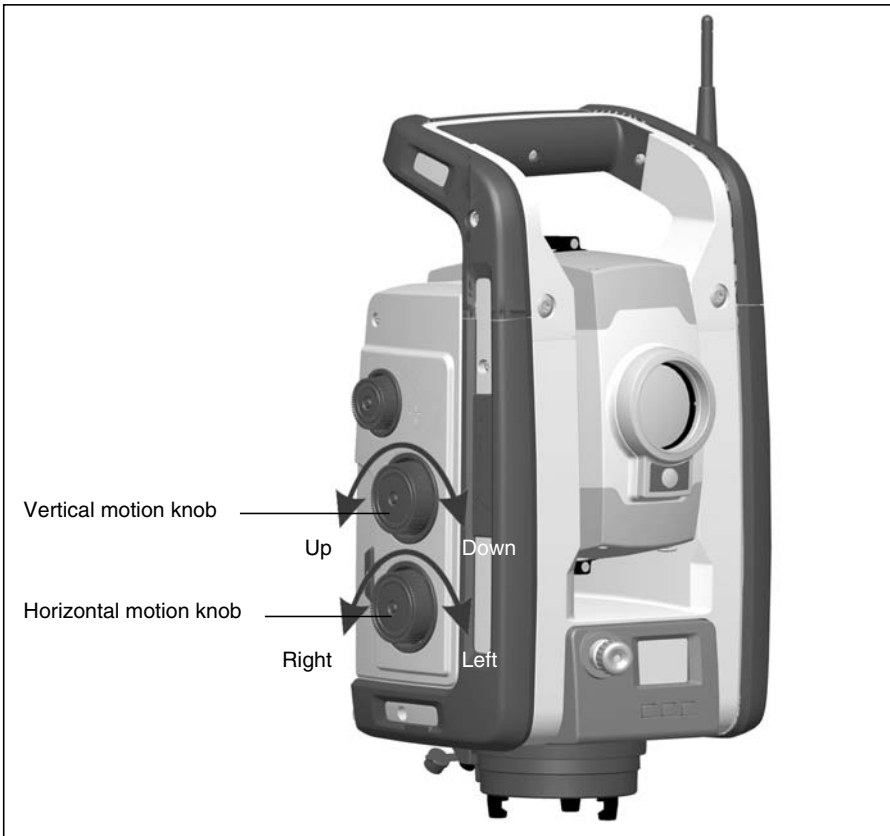

Figure 6.51 Position servo

Focus Servo

The instrument is equipped with a focus servo. The focus motion knob is on the side of the instrument for easy access.

The focus knob is connected to a servo motor that is built into the telescope. When you turn the focus motion knob, the servo motor adjusts the focusing lens. See figure 6.52



Figure 6.52 Focus servo

Power Management

The power management in the Trimble SPSx30 Total Station instrument can set the instrument to one of three different modes.

- Off mode
- On mode
- Suspend mode

Stand Alone

Instrument only, no Trimble CU connected.

Off Mode

In the off mode the On/Off key LED and face 2 display is off.

Press the On/Off key for 1 second. to turn on the instrument. The instrument will also turn on if you connect a 12 V power supply or data communication cable to the communication (COM) connector.

Note – During startup the On/Off key LED will flash once every second.

On Mode

In the on mode the On/Off key LED will be on solid, the face 2 display will be on.

To turn off the instrument press the On/Off key for 3 seconds.

The instrument will go to off mode if the battery is very low (battery capacity less than 2%).

If not used for 300 seconds (5 min.) the instrument will go to Suspend mode.

Suspend Mode

In the suspend mode the On/Off key LED will flash once every other second, the face 2 display will be off.

To turn the instrument on press the On/Off key for 1 second or turn on the instrument from a remote application.

To turn the instrument off press the On/Off key for 3 seconds.

In Suspend mode the instrument will turn off automatically at suspend time out. The suspend time out is set in the Trimble CU operating system.

Instrument with Trimble CU Connected

Off Mode

In the off mode the On/Off key LED and face 2 display is off. The Trimble CU will be off or in suspend mode.

To turn the instrument on press the On/Off key for 1 second or press the Trimble CU power key. The instrument will also turn on if you connect a 12 V power supply or data communication cable to the communication (COM) connector.

Note – During startup the On/Off key LED will flash once every second.

On Mode

In the on mode the On/Off key LED will be on solid, the face 2 display will be on. The face 2 display will be controlled by the Trimble CU application program. The attached Trimble CU will be on and the suspend mode back up battery in the Trimble CU will be charging.

To turn off the instrument press the On/Off key for 3 seconds or press the Trimble CU power key. Depending on the settings in the Trimble CU operating system the instrument will turn off or go to suspend mode.

The instrument will go to suspend mode if the battery is very low (battery capacity less than 2%).

Suspend Mode

In the suspend mode the On/Off key LED will flash once every other second, the face 2 display will be off. The attached Trimble CU will be in suspend mode and the suspend mode back up battery in the Trimble CU will be charging.

To turn the instrument on press the On/Off key for 1 second or press the Trimble CU power key.

To turn the instrument off press the On/Off key for 3 seconds.

This will only turn off the instrument. The Trimble CU will be in suspend mode until suspend time out occurs.



Caution – When the Trimble CU is removed from the instrument it is recommended to have the Trimble CU in suspend mode.

Removing the Trimble CU from the instrument when in on mode will not damage the equipment, but files that are being saved or written to when the Trimble CU is being removed might be damaged or lost.

Power Supply

The power management in the Trimble SPSx30 Total Station has been designed to deliver the most operating time in the field. The power management system includes the internal battery, optional external Trimble or third party battery pack and the Trimble battery charger.

Internal Power Supply

The primary power supply for the Trimble SPSx30 Total Station is a rechargeable, removable Lithium-ion battery. The supplied battery is designed for use in the Trimble SPSx30 Total Station and features:

- Battery gauge to easily check power supply
- Rugged design
- One battery type for Trimble SPSx30 Total Station and accessories.

The Trimble SPSx30 Total Station battery is on the side of the instrument and is easily removed and replaced. See figure 6.53

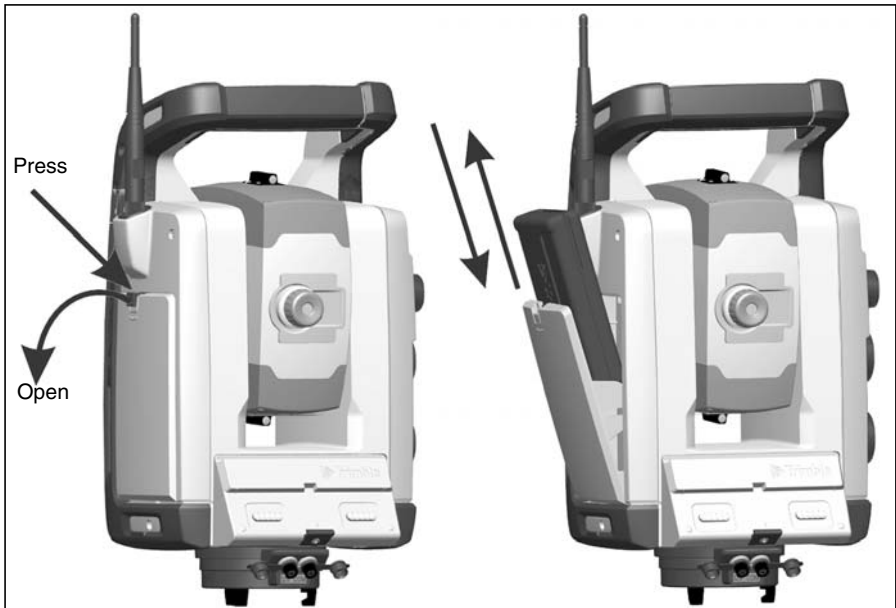

Figure 6.53 Removing and replacing the internal battery

To check the power supply in the Trimble SPSx30 Total Station battery using the built in battery gauge, press the button on the side of the battery. See figure 6.54



Figure 6.54 Internal battery power gauge and button

When you press the button, four LEDs on the Trimble SPSx30 Total Station battery show the power level. Each LED corresponds to a power level of 25% so that when the power level is at 100%, all four LEDs are lit. If the battery is completely discharged, all LEDs are unlit.

When the button is pushed and all the LEDs flash, the battery needs to be reconditioned in the battery charger, See Conditioning the Battery on page 18.

When the battery capacity is between 0 and 10% one LED is flashing. A battery with a flashing LED might not be able to start an instrument or a Trimble CU. If started, with a battery with a flashing LED, the operating time will be between 5 and 15 minutes.

The capacity of the battery is 4.4 Ah.

External Power Supply

The Trimble SPSx30 Total Station instrument has two external ports in the base of the instrument; one for communication and one for an external power supply. External power can be provided by one of the following:

- Multi Battery Adapter
- Car battery
- Car cigarette lighter

With the Trimble SPSx30 Total Station Multi Battery Adapter, you can connect up to three Trimble SPSx30 Total Station batteries. Connect the Multi Battery Adapter to the external power port on the Trimble SPSx30 Total Station instrument using a grey Trimble cable with 6-pin Hirose connector.

The Trimble SPSx30 Total Station Multi Battery Adapter can be attached to a tripod or placed on the ground, and has a carrying handle.

Use one of the following as an alternative to the Multi Battery Adapter:

- An external 12 V car battery. Use the car battery cable to connect the 12 V battery to the external power port on the Trimble SPSx30 Total Station.

Note – For all non Trimble batteries, use the SCS900 software to configure the instrument to "understand " the operating properties of the connected battery. Setting up a third party battery correctly in SCS900 will result in good operating times in addition to protection for the battery, stopping it from being deep discharged rendering it useless.



Caution – Use only the gray cables with 6-pin Hirose connectors from Trimble when connecting a cable to the instrument and Multi Battery Adapter.

Charging the Battery

The Trimble SPSx30 Total Station instruments are offered with a Dual slot battery charger that can charge two batteries or a battery charger that can charge five batteries one after the other. Connect the charger to the AC to DC converter. Connect the AC to DC converter to 100 V–250 V 50 Hz–60 Hz power. See figure 6.55.

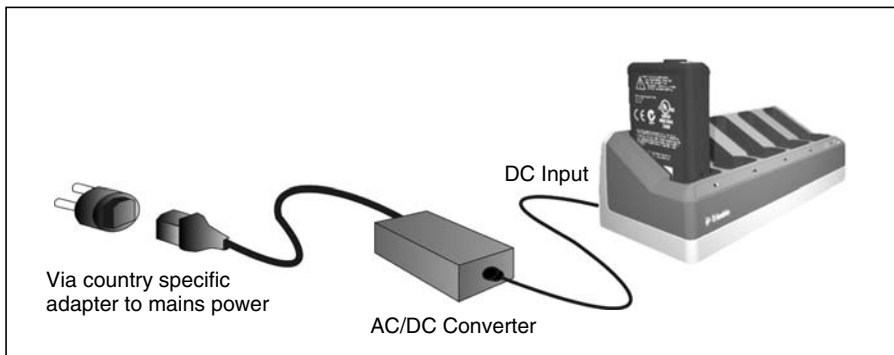

Figure 6.55 Charger and battery



Tip – The battery charger can also be used to charge the Trimble 7.4 V Li-Ion batteries used in the MT1000 Multitrack target and the SPS882 GNSS Smart Antenna receiver, see figure Figure 6.56

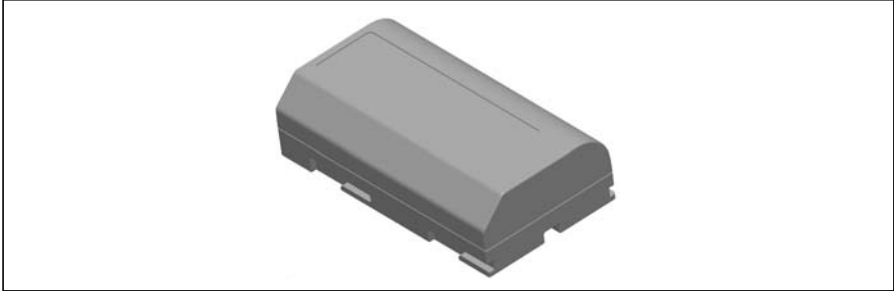

Figure 6.56 Trimble 7.4 V Li-Ion battery

Battery Low Message

If the battery capacity drops too low, the **Bat Low** message appears in the Trimble CU display window and the instrument shuts down. You must then change the battery within two hours to prevent losing instrument parameters and functions such as instrument height, target height, coordinates, bearing, and dual axis compensation. After that time, the system resets all parameters and functions to default values.

Note – This safety backup of the instrument parameters and functions will work only when **Bat low** appears on the display: it will not function if you remove the battery during operation.

External Communication

The communication port on the base of the Trimble SPSx30 Total Station can be used for external communications to a computer or data collector.



Caution – Use only the gray cables with 6-pin Hirose connectors from Trimble when connecting a cable to the instrument.

Options & Accessories

In this chapter:

- Trimble Stake Writer Rod
- Trimble MT900 Target
- Junction Box
- Trimble MT1000 MultiTrack Target
- Measuring the Backsight Target Height
- Trimble Robotic Holder
- Radio
- Radio Antenna Extension Kit

Trimble Stake Writer Rod

The Trimble stake writer rod is available with the Trimble SPSx30 Total Station. The rod contains the following features:

- Graduated scale in meters and feet.
- Fixed target height positions
- Leveling bubble
- Topo shoe for working on soft or uneven ground

Trimble Target ID

The target ID is an optional unit that connects to the Trimble stake writer rod to transform the prism from a passive target to an active target. See figure 7.57

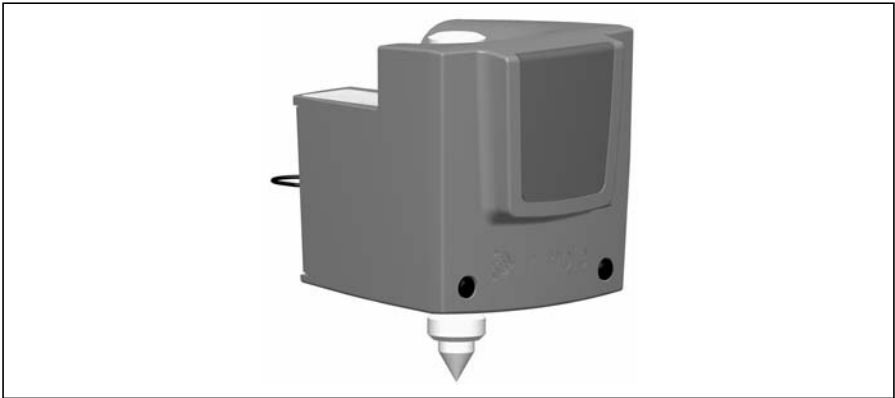

Figure 7.57 Trimble Target ID

You can configure the target ID to eight different IDs, which are then used by the Trimble SPSx30 Total Station to ensure that the instrument locks onto and (optionally) tracks only the target with the correct Target ID. Configure the Target ID through its own LED display. See figure 7.58

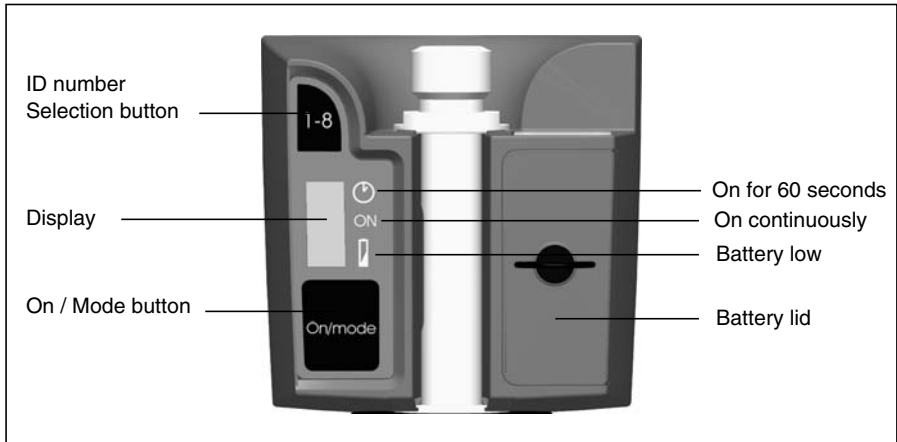

Figure 7.58 Target ID controls

Press the power button one or more times to access the following modes:

- On for 60 seconds
- On continuously
- Off

A bar appears beside the active mode.

When the Target ID is on, the current target ID appears. Press the ID number selection button to change the current target ID number.

The Target ID is powered by two AA size batteries that will operate the unit for approximately 12 hours continuous use. A dot appears beside the battery symbol when battery power is low.

Fitting and Removing the Target ID

1. Screw the adapter and mini rod on to the top of the rod and tighten.
2. Push the Target ID on to the mini rod until it locks in place. The spring lock will hold the Target ID in place.

Removing the Target ID is the reverse operation to fitting.

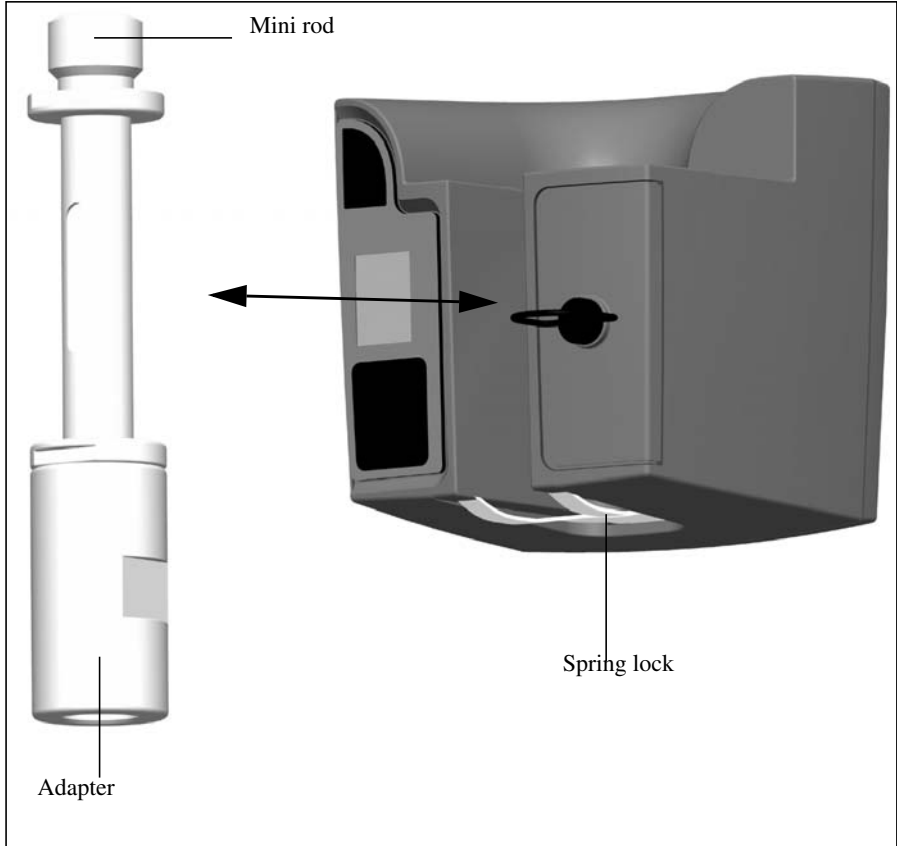

Figure 7.59 Fitting or removing the Target ID.

LED Information

The Target ID has been tested and complies with the regulations for a Class 1 LED product. See figure 7.60. See Laser Safety on page v.

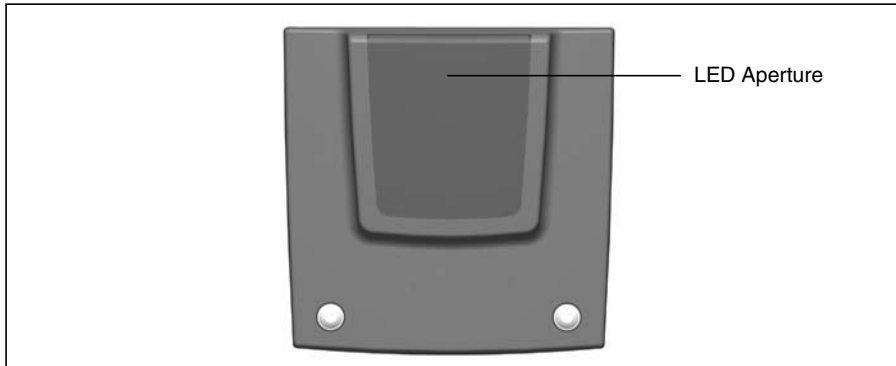

Figure 7.60 Target ID LED Aperture

Changing the Batteries in the Target ID

1. Turn the screw securing the battery lid a quarter of a turn counter-clockwise and then remove the battery lid.
2. Hold the target ID at an angle and let the two used batteries slide out.
3. Insert two new AA size batteries.
4. Fit the battery lid and then secure it by turning the screw a quarter of a turn clockwise. See figure 7.61

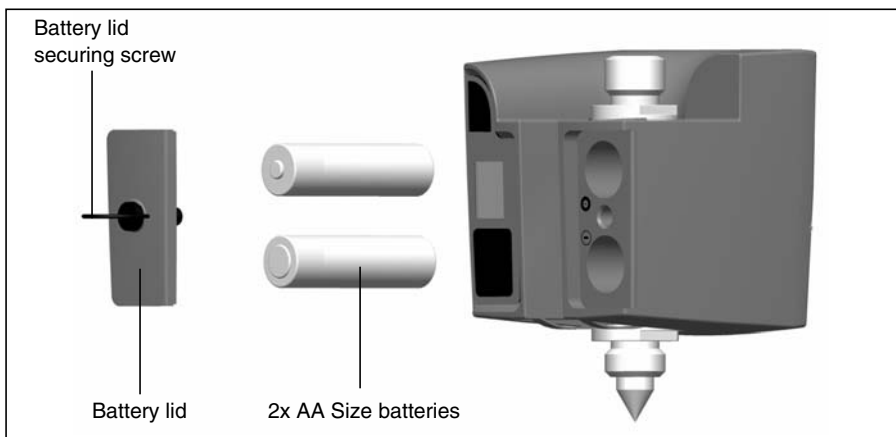

Figure 7.61 Target ID battery change

Trimble MT900 Target

For Machine Control and Machine Guidance (Not available on all models) the Trimble SPSx30 use the MT900 Target. The target is designed with reflective tape instead of glass prisms. The tracker operates in a fully active mode, using the Target ID LEDs for both horizontal and vertical tracking of the target. The reflective tape is used for measurement. The LEDs are arranged so that every alternate LED points up or down, delivering the ability to operate at up to +/- 45 degrees from the horizontal. The LEDs emit the target ID, and can be programmed using 16 unique channels, allowing for up to 16 unique targets operating in the same area without risk of false target lock. Channels 8-16 are reserved for the MT900 working in conjunction with an SPSx30.

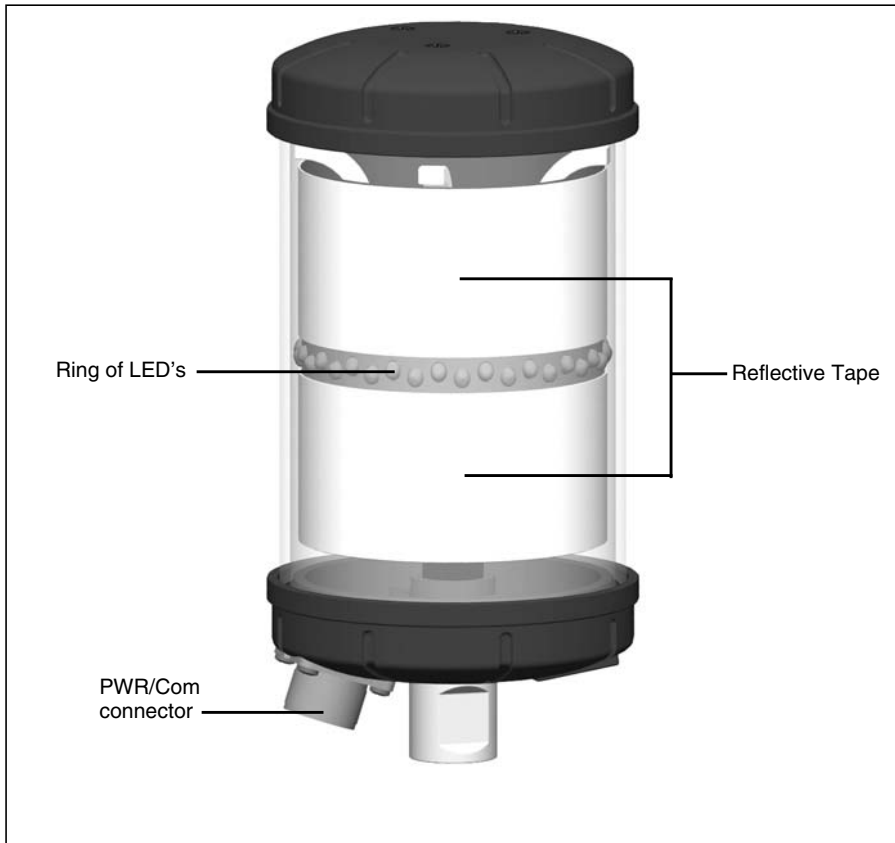

Figure 7.62 MT900 Target

When the MT900 target is mounted on a machine it is controlled and set up via the CAN serial bus.

If the target is mounted on a vehicle, ATV or machine without CAN serial bus, the target must be connected to a junction box. The target can then be controlled and set up via a serial port from a computer.

***Note** – if two targets are going to be used in close proximity e.g. on a machine, Trimble recommends that you set each target on a different Target ID channel and put as large a gap as possible between the channels e.g. channel 4 and 12 to avoid any likelihood of interference when both targets are in the field of view. Trimble also recommends that the two targets are set at different heights to avoid the likelihood of both targets being in the same field of view / line of sight at the same time. Where only a part of the target will be used e.g. on a Tunnel drilling Jumbo where the instrument is placed behind the machine, Trimble also recommends that the unused parts of the target be obscured using plastic pipe to avoid any likelihood of stray reflections from the machine or surrounding infrastructure which can cause mispointing of the instrument through false lock ons to reflected signals.*

Junction Box

The junction box is needed when the MT900 Target is to be mounted on a vehicle or machine without a CAN serial bus. The junction box is connected to a power supply, target and a computer's serial communication port.

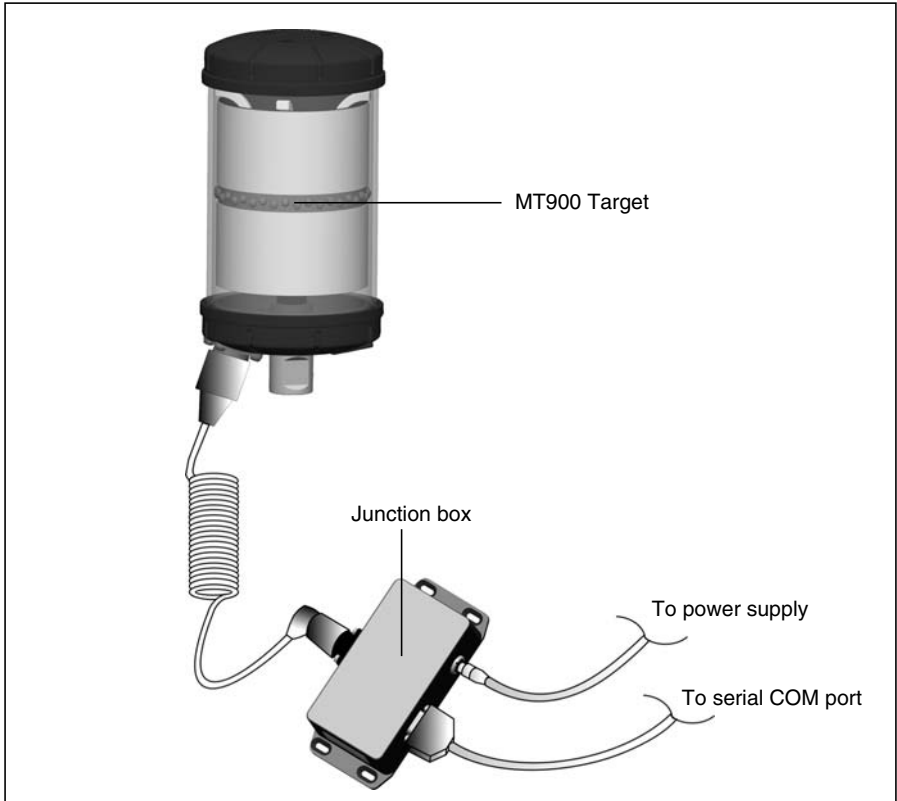

Figure 7.63 Connecting the Junction Box

Trimble MT1000 MultiTrack Target

The Trimble MultiTrack™ target provides fully coaxial passive and active tracking via an integrated 360° prism ring and 2 active 360° LED rings. The active LED rings support the selection of a unique ID to ensure that 8 different targets can be operated on a single site with full confidence that the correct target is always used.

Features

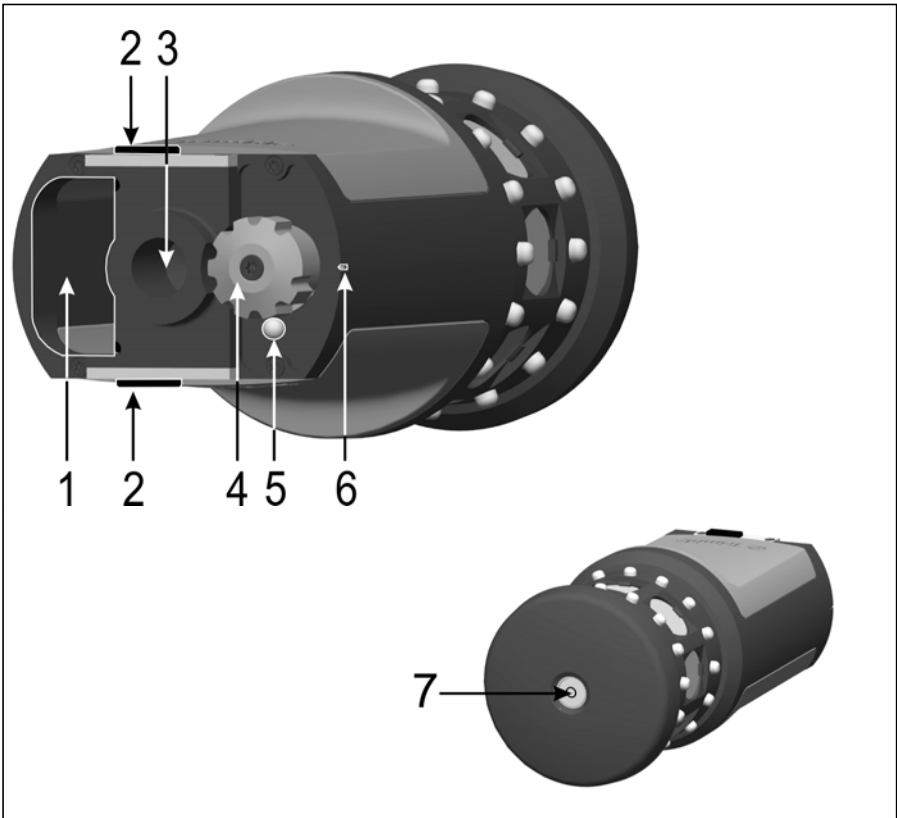

Figure 7.64 Trimble MT1000 MultiTrack target features

- | | | | |
|---|--------------------------------|---|--------------------------------------|
| 1 | Battery compartment | 5 | On/Off and battery low indicator LED |
| 2 | Battery locks | 6 | Position indicator |
| 3 | 5/8" Thread | 7 | Circular level |
| 4 | Channel select (on/off switch) | | |

Measures

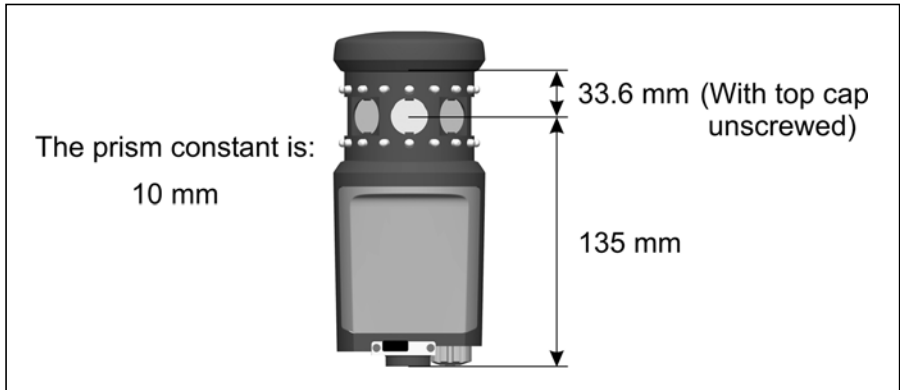

Figure 7.65 Trimble MT1000 MultiTrack target measures

Fitting and Removing the Battery

To fit the battery, push the battery in to the battery compartment (1) with the battery connectors (2) facing upwards and inwards until the battery locks clicks (3) in place.

To remove the battery, slide the battery locks open (4), The battery can now slide out of the battery compartment (5).

The battery is a Trimble 7.4 V Li-Ion battery.

The Trimble MultiTrack Target will provide active tracking for up to 8 hours from one fully charged battery. When the on/off and battery low indicator LED starts to flash the battery will have approximately 40 minutes operation time remaining.

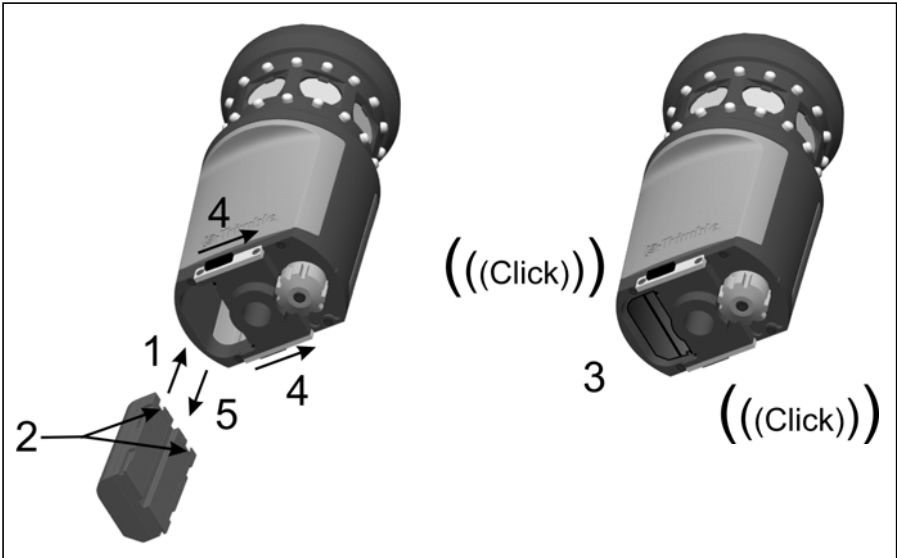

Figure 7.66 Fitting and removing the battery

Specification Label

To read the specification label unscrew the top cap of the target (1) as shown in figure 7.67.

Note – The accuracy specification for Active mode is valid within 15° from horizontal. For vertical angles outside of this range it is recommended to use passive mode or to use a tiltable target to ensure the most precise results.

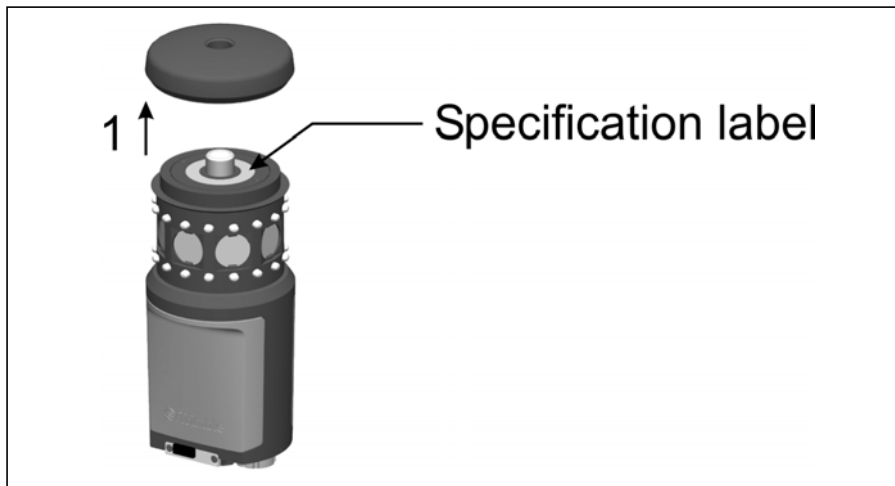

Figure 7.67 Specification label

Measuring the Backsight Target Height

There is a height measurement mark on the side of the prism base that can be turned out for easier reading of the height. The height measurement mark is 0.158 m (0.518 ft.) below the target (signal) height. Measure to the top ridge of the mark. See figure 7.68

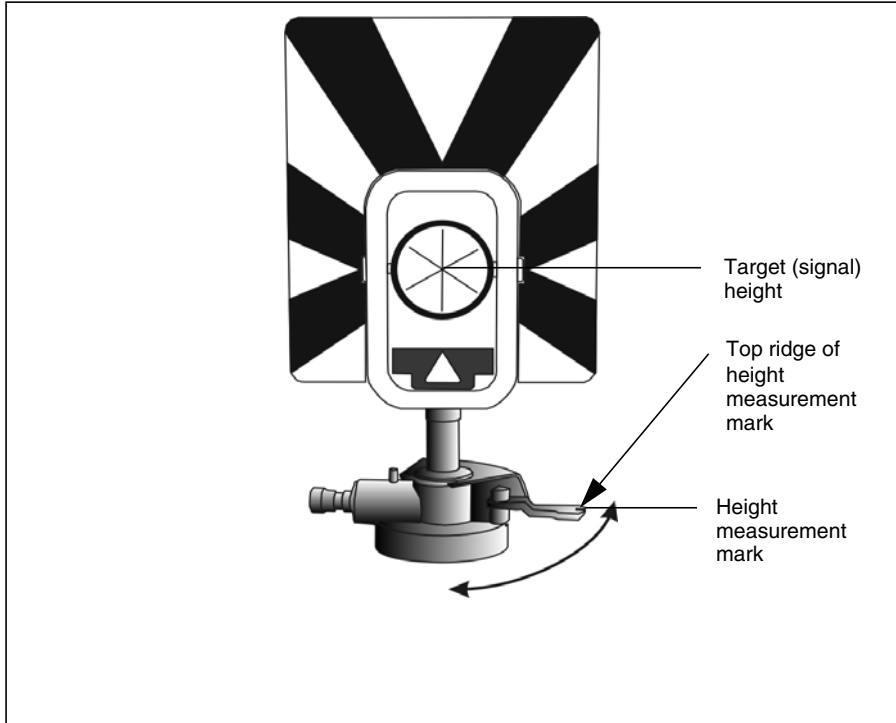

Figure 7.68 Target height marks

When there is a Trimble CU attached running a field application software such as SCS900, the software has additional functions that reduce the bottom mark measurement to the required vertical target (signal) height. See figure 7.69 and the following paragraph.

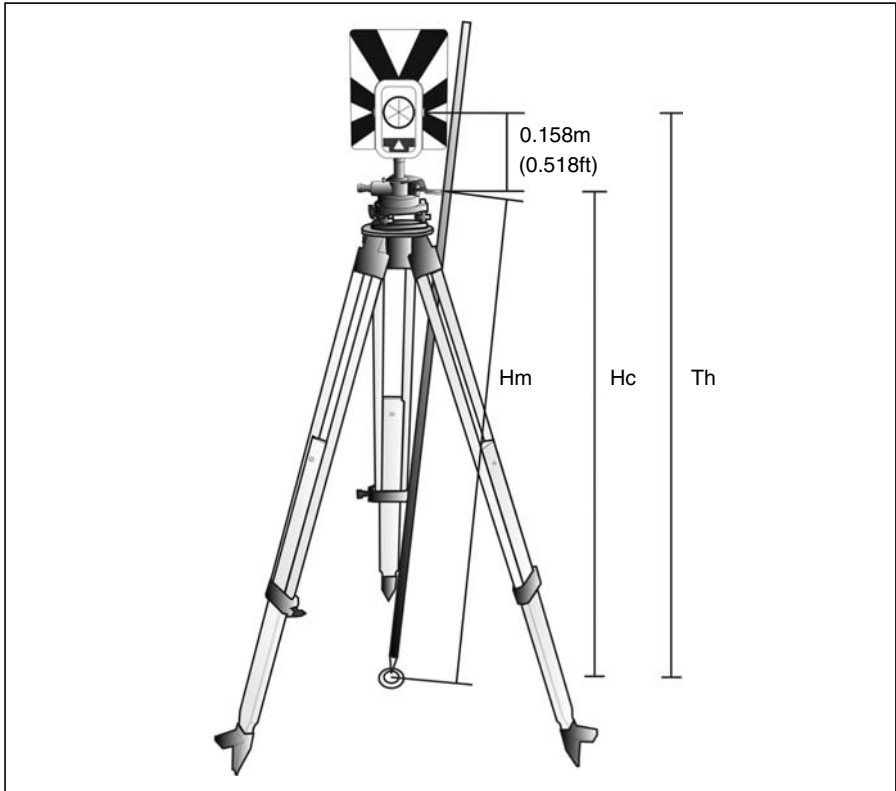

Figure 7.69 Target height measurement

The measured distance (Hm) is corrected for the slope of the measurement to obtain a vertical measurement to the bottom mark (Hc). The constant from the target height measurement mark to the target (signal) height (0.158 m/0.518 ft.) is added to the Hc to obtain the vertical target height from the ground mark to the target (signal) height (Th). For more information, refer to the field software documentation.

Alternatively, to obtain an accurate measurements to the target (signal) height (Th), you can manually measure the slope distance from the ground to the bottom mark (Hm). To calculate the total target height (Th), insert the measured slope distance (Hm) into the formula below:

$$Th = 0,158 + \sqrt{Hm^2 - 0,091^2}$$

Trimble Robotic Holder

The Trimble Robotic Holder holds the Trimble CU when the instrument is operating in robotic mode. See figure 7.70



Figure 7.70 Trimble robotic holder with Trimble CU and radio

The Trimble Robotic Holder includes the following features:

- Secure Trimble CU connection with quick release
- Secure Trimble SPSx30 Total Station battery connection with quick release
- Built in 2.4 GHz radio
- Rugged ergonomic design with safety bumper to protect the Trimble CU
- Quick release from pole connector
- Two ports for external power supply and external communications (USB)

The Trimble SPSx30 Total Station battery powers the Trimble CU and radio during robotic operation.

You can use a USB memory stick or USB Compact Flash Card adapter with the Trimble Robotic Holder to transfer data between the office and the field or between two field devices e.g. From SCS900 to a GCS900 or SiteVision Machine Control system. Connect the device memory through the USB cable to the external communications port on the Trimble Robotic Holder. Use Microsoft Windows Explorer or the dedicated SCS900 file transfer functions to transfer the files from the Trimble CU to the memory device.



Caution – Use only the gray cables with 6-pin Hirose connectors from Trimble when connecting a cable to the Trimble Robotic Holder.

Power Management

Off Mode

In the off mode the Robotic Holder will be off. The Trimble CU will be off or in suspend mode.

To turn on the Robotic Holder and the Trimble CU press the Trimble CU power key. The Robotic Holder and Trimble CU will also turn on if you connect +12 V or data communication cable to the side connector.

On Mode

In the on mode the Robotic Holder will be on. The attached Trimble CU will be on and the suspend mode back up battery in the Trimble CU will be charging.

To turn off the Robotic Holder and the Trimble CU press the Trimble CU power key. Depending on the settings in the Trimble CU operating system the instrument will turn off or go to suspend mode.

The Robotic Holder and the Trimble CU will go to suspend mode if the battery level is low (battery capacity less than 2%).

Suspend Mode

In the suspend mode the Robotic Holder and the attached Trimble CU will be in suspend mode and the suspend mode back up battery in the Trimble CU will be charging.

To turn on the Robotic Holder and the Trimble CU press the Trimble CU power key.

The Robotic Holder and the Trimble CU will be in suspend mode until suspend time out occurs.



Caution – When the Trimble CU is removed from the Robotic Holder it is recommended to have the Trimble CU in suspend mode.

To remove the Trimble CU from the instrument when in on mode will not damage the equipment, but files that are being saved or written to when the Trimble CU is being removed might be damaged or lost.

Attaching a Battery

1. Fit the battery on to the hooks on the holder (1).
2. Push the battery on to the holder until it clicks into place (2). See figure 7.71

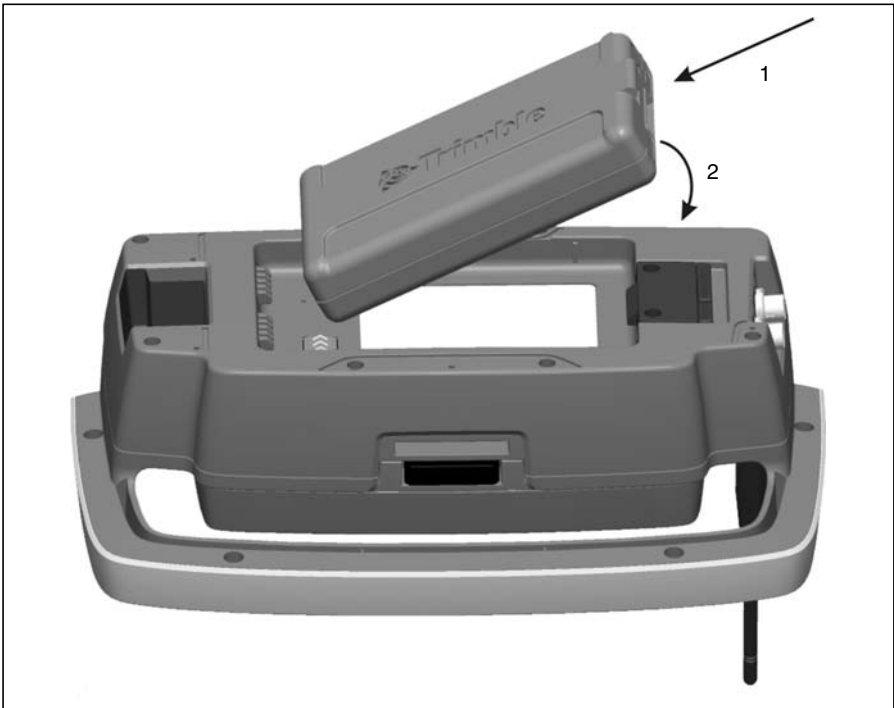

Figure 7.71 Attaching a battery to the Trimble Robotic Holder

Detaching a Battery

1. Pull the battery lock mechanism away from the battery (1).
2. Lift up this side of the battery (2).

3. Remove the battery from the holder (3). See figure 7.72.

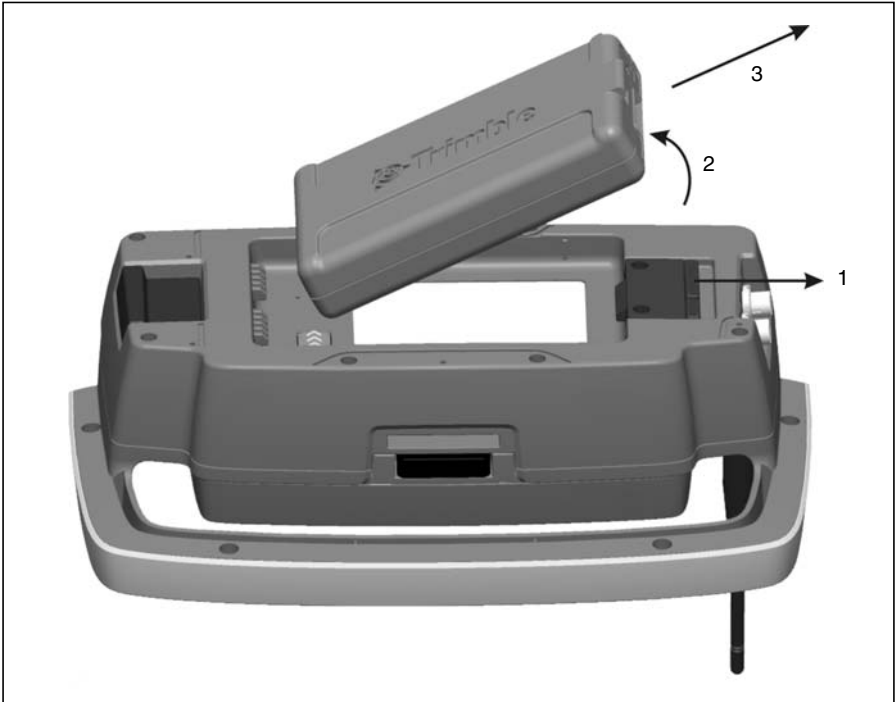

Figure 7.72 Detaching a battery from the Trimble Robotic Holder

Attaching a Trimble CU

1. Hook the top of the Trimble CU over the top edge of the holder (1).
2. Push the bottom of the Trimble CU towards the holder until it locks in place with a click (2), figure 7.73.



Figure 7.73 Attach Trimble CU to Trimble Robotic Holder

Detaching a Trimble CU



Caution – Make sure to switch off the Trimble CU before it is detached from the instrument.

1. Push the lock release button on the bottom of the Trimble CU (1) and lift the bottom of the Trimble CU away from the holder (2).
2. Unhook the top of the Trimble CU from the top edge of the panel attachment and remove the Trimble CU from the holder (3), figure 7.74.



Figure 7.74 Detach Trimble CU from Trimble Robotic Holder

Attaching the Trimble Robotic Holder to the Rod

To attach the Trimble Robotic Holder, slide the holder onto the stake writer rod adapter until the holder locks into place with a click, figure 7.75.



Figure 7.75 Attaching the Trimble Robotic Holder to the stake writer rod adapter

Detaching the Trimble Robotic Holder from the Rod

1. To detach the Trimble Robotic Holder from the rod, pull the release mechanism (1) as shown in figure 7.76
2. Slide the holder off the stakewriter rod bracket (2) as shown in figure 7.76.



Figure 7.76 Detach Trimble Robotic Holder from stake writer rod adapter



Caution – The Trimble CU and Robotic holder are not designed for mounting on a vehicle. For vehicle or ATV always use the TSC3 or Trimble Tablet controller, which have been designed to withstand the shock and vibration conditions associated with that type of use. Mounting the Trimble CU and Robotic holder in these situations is not recommended, and puts your equipment at risk of damage that is not covered by warranty.

Radio

Internal Radio

The Trimble SPSx30 Total Station has an internal radio to support robotic and Machine Control and Machine Guidance operations.

The internal radio is a 100 mW radio that operates in the public free 2.4 GHz band. The radio uses frequency hopping technology to reduce radio interference and maintain radio communications in even the harshest RF environment.

The Trimble SPSx30 Total Station radio baud rate is 115200 bps. This high baud rate reduces the measurement latency, which ensures that a measurement viewed at the pole is received 100 msec after the measurement is sent from the instrument.

To maintain radio communication with the Trimble SPSx30 Total Station instrument, the Trimble CU at the pole must also be connected to a 2.4 GHz external radio. The radio for the Trimble CU is available as an optional integrated module in the Trimble robotic holder. The radio for the TSC2 is also available as an optional integrated 2.4 GHz radio module. The radio for machine control is the SNR2400 radio.

Radio Link and Machine Control

When used in Machine Control or Machine Guidance the radio link uses radio channels 31 through 60 instead of channels 1 through 30 that are used for Site Positioning.

Setting of Radio Channel and Network ID

Several different systems can use the same radio channel at the same time but each pair of machine-instrument must use the same unique network ID. The radio channel and network ID for machine control use must be set using the Trimble SCS900 software. These can not be set from the face 2 display.

External Radio 2.4 GHz

An external radio is available as an option for robotic measurements when using a controller not fitted with an internal radio. . The External Radio 2.4 GHz uses one 7.4 V Li-Ion battery as power supply. This will give the radio 15 hours with a 2.4 Ah battery. Global radio part number: SPS4201 and France radio part number: SPS4202. For technical information see Internal Radio page 137.

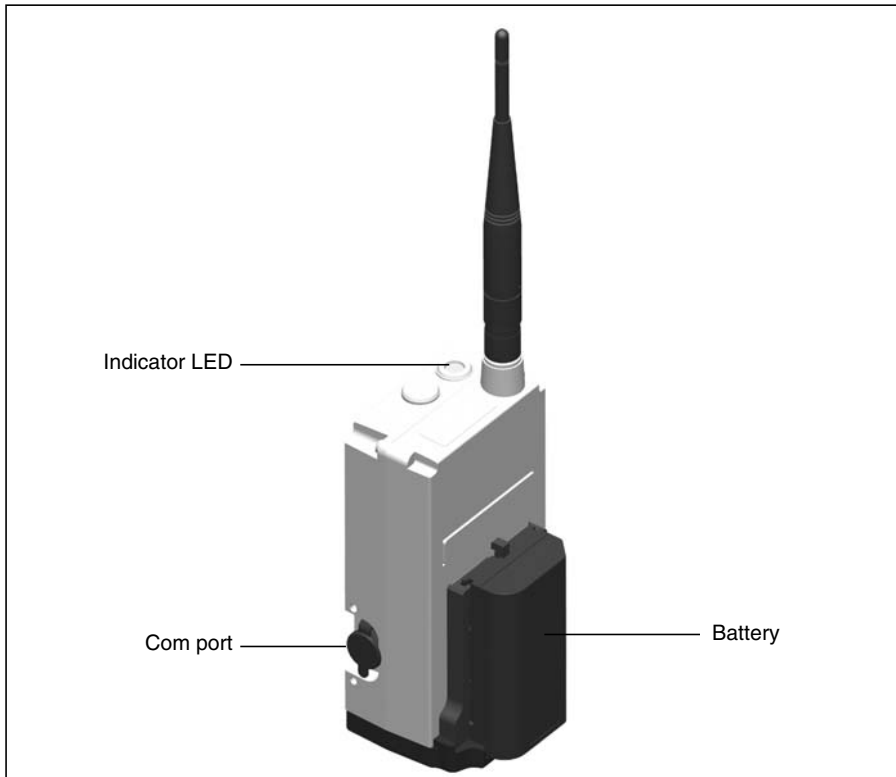

Figure 7.77 External radio 2.4 GHz

For information regarding charging of the battery. See Power Supply on page 111



Caution – Always remove the battery from the external radio after use.

Attaching the Battery

To fit the battery to the radio:

1. Fit the battery to the battery holder.

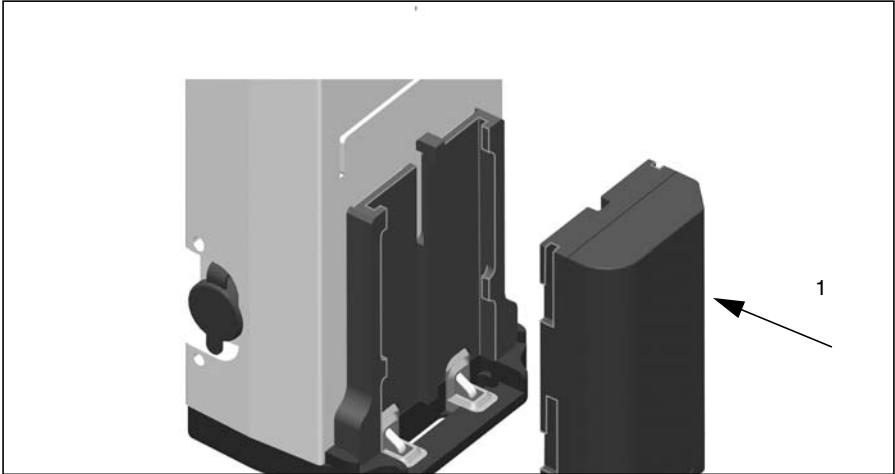

Figure 7.78 Fitting battery to external radio

2. Push the battery downwards until the catch clicks in place.

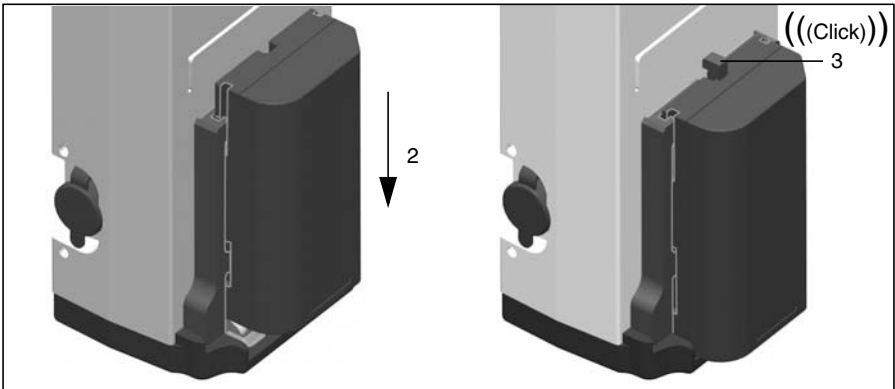

Figure 7.79 Fitting battery to external radio

Detaching the Battery

To remove the battery from the radio:

1. Press the catch towards the radio.
2. Slide the battery upwards.

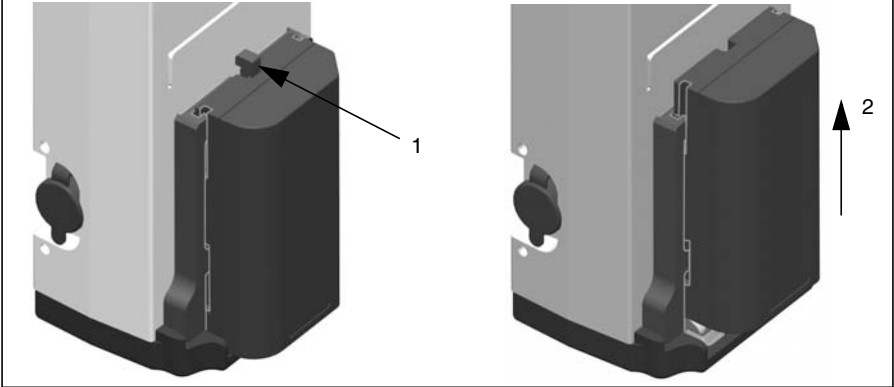

Figure 7.80 Removing battery from external radio

3. Pull the battery away from the battery holder

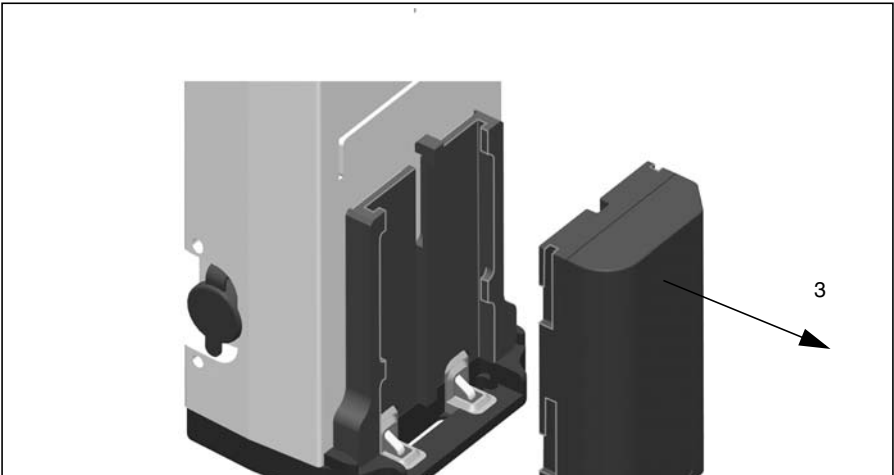

Figure 7.81 Removing battery from external radio

Radio Antenna Extension Kit

For extended radio range it is possible to fit an antenna extension kit part.nr: 58313001 to get the radio antenna to a higher position on the rod where it is clear from obstruction by the user or the rod itself. When working at the maximum radio range, this can make a significant difference.

The antenna extension kit consists of:

Item	Description
a	Antenna holder
b	Antenna cable
c	Washer
d	Locking washer
e	Nut

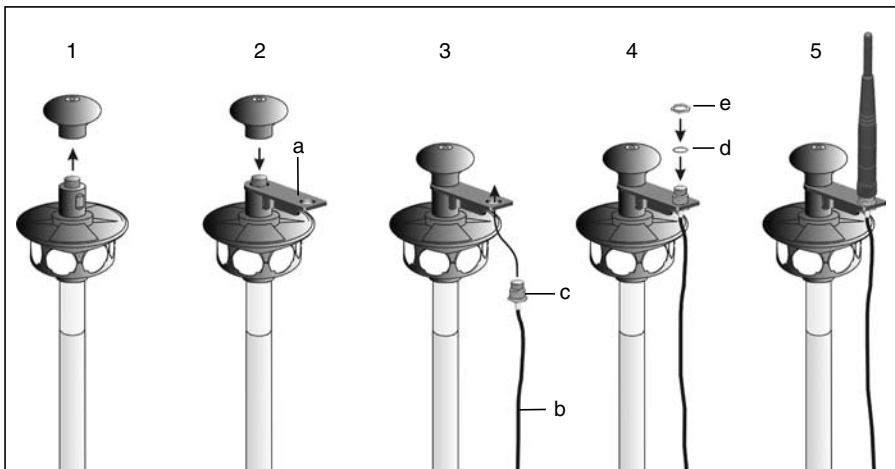

Figure 7.82 Fitting the antenna extension kit.

1. Unscrew and remove the top part of the 360° prism.
2. Fit the antenna holder (a) over the thread and re-fit the top part of the 360° prism.
3. Fit the washer (c) on the antenna cable (b) and fit the antenna cable (b), from underneath, to the antenna holder.
4. Fit the locking washer (d) and nut (e).
5. Fit the antenna on top and connect the antenna cable to the antenna connector on the Trimble Robotic Holder.

Index

A

- Accessory case
 - Backsight Target kit 10
 - fitting 11
 - power kit 8
 - robotic kit 9
- adjusting
 - the laser beam 72–75
 - the optical plummet 78
- adjustments menu 54
- aligning the laser beam 72–75
- aligning the laser pointer 72–75

B

- batteries
 - charging 17–18, 113
 - conditioning 18–19
 - connecting external 23
 - connecting internal 21
 - disposing of 16
 - external 22
 - safety and environment information 16
- battery change, Target ID 119
- battery Charger LED Behavior 20
- battery charging system 113
- battery low 114
- beam
 - adjustment 72–75
 - alignment 72–75
 - divergence 99

C

- care and maintenance 12
- carrying straps 6–7
- charging the batteries 17–18, 113
- cleaning 12
- Collimation
 - error 94
 - test 58–63, 95
- communication 114
- compensator calibration 55
- Control Unit
 - attaching 81
 - detaching 82
- correction for deviation of plumb axis 94
- Cover for panel holder
 - attaching 81
 - detaching 82

D

- Declaration of Conformity
 - Trimble 2.4 GHz radio xii
 - Trimble SPS Series xi
 - Trimble Target ID xiii
- DR Plus, laser and LED information 32–33

E

- environmental information
 - batteries 16
 - European Union viii
- European Council Directive 89/336/EEC 2

exit menu 71
external battery 22
external power supply
 power supply, external 112

F

Face 2 Display 27
firmware version 68, 70

H

HA/VA Collimation 58–63
handle
 attaching handle 31
 detaching handle 30

I

instrument
 attaching handle 31
 detaching handle 30
 height marks 76
 height measurement 76–77
 lifting 87

J

Junction box 121

L

Language 70
laser and LED information
 DR Plus 32–33
 Target ID 119
laser pointer
 adjustment target for DR
 Plus 73

alignment 72–75
 turning on or off 53, 65, 68,
 70
 warning label 32

LEDs, battery charger 20
levelling 40
lifting instrument 87

M

Min.-Max Range 98
MT900 Target 120
Multi Battery Adapter 22

O

On/Off key 26
optical plummet 29, 78

P

packing for Transport 13
plumb axis correction 94
power management 111
precision measurement hints 36

R

radio
 external 138
 internal 137
Robotic Holder 129–136

S

safety
 battery vii–viii
 laser and LED v–vii
Servicing 13

- servo
 - focus 107
 - Horizontal and vertical position 107
- Servo demo mode 68
- site measurement
 - with Autolock 90
 - with robotic 91
 - with servo 90
- stake writer rod 116

T

- target
 - height measurement 127–128
 - height measurement mark 127
- target ID
 - battery change 119
 - laser and LED information 119
 - option 116–119
- Tracker
 - Aiming 104
 - collimation 63–64, 95
 - passive target 102
 - Tracker technology 102
- Tracklight 105–106
- trunnion axis tilt 59–63, 96
- trunnion axis tilt test 96

W

- warning label
 - laser pointer 32
- Weak Signal 98